

Chapter 2

Parametric Modeling Fundamentals

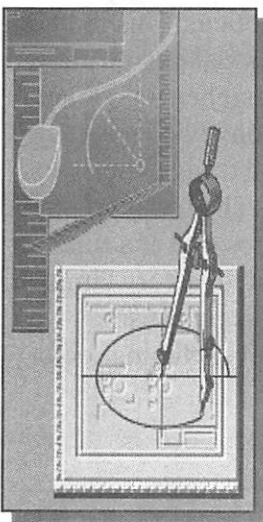
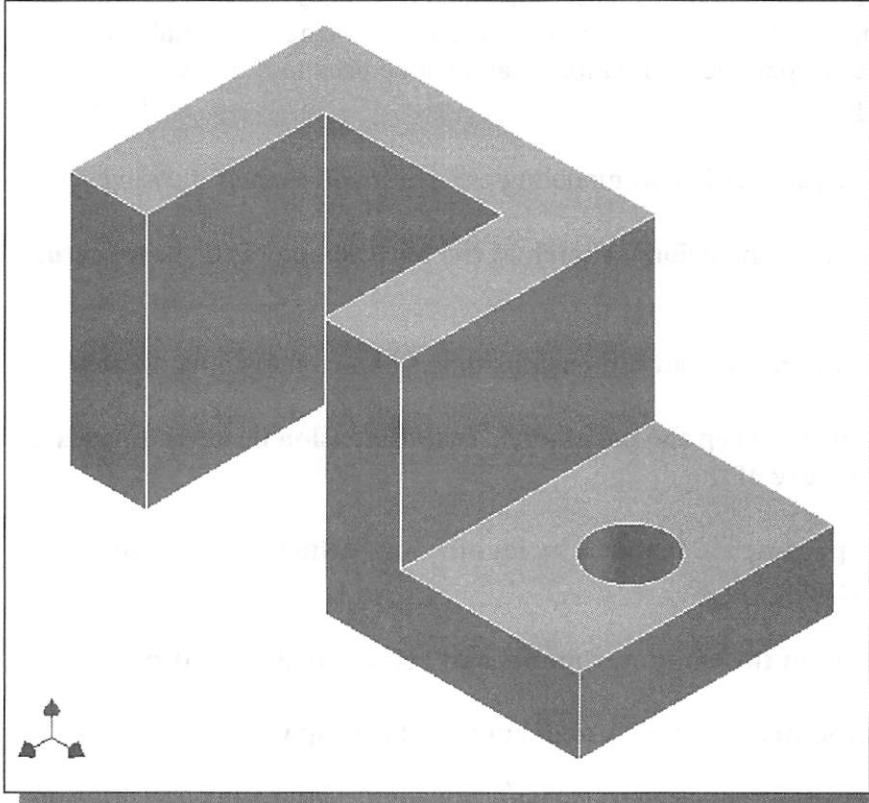

Learning Objectives

- ◆ Create Simple Extruded Solid Models
- ◆ Understand the Basic Parametric Modeling Procedure
- ◆ Create 2-D Sketches
- ◆ Understand the “Shape before Size” Design Approach
- ◆ Use the Dynamic Viewing Commands
- ◆ Create and Edit Parametric Dimensions

Introduction

The **feature-based parametric modeling** technique enables the designer to incorporate the original **design intent** into the construction of the model. The word *parametric* means the geometric definitions of the design, such as dimensions, can be varied at any time in the design process. Parametric modeling is accomplished by identifying and creating the key features of the design with the aid of computer software. The design variables, described in the sketches as parametric relations, can then be used to quickly modify/update the design.

In *Autodesk Inventor*, the parametric part modeling process involves the following steps:

1. **Create a rough two-dimensional sketch of the basic shape of the base feature of the design.**
2. **Apply/modify constraints and dimensions to the two-dimensional sketch.**
3. **Extrude, revolve, or sweep the parametric two-dimensional sketch to create the base solid feature of the design.**
4. **Add additional parametric features by identifying feature relations and complete the design.**
5. **Perform analyses on the computer model and refine the design as needed.**
6. **Create the desired drawing views to document the design.**

The approach of creating two-dimensional sketches of the three-dimensional features is an effective way to construct solid models. Many designs are in fact the same shape in one direction. Computer input and output devices we use today are largely two-dimensional in nature, which makes this modeling technique quite practical. This method also conforms to the design process that helps the designer with conceptual design along with the capability to capture the *design intent*. Most engineers and designers can relate to the experience of making rough sketches on restaurant napkins to convey conceptual design ideas. *Autodesk Inventor* provides many powerful modeling and design-tools, and there are many different approaches to accomplishing modeling tasks. The basic principle of **feature-based modeling** is to build models by adding simple features one at a time. In this chapter, the general parametric part modeling procedure is illustrated; a very simple solid model with extruded features is used to introduce the *Autodesk Inventor* user interface. The display viewing functions and the basic two-dimensional sketching tools are also demonstrated.

The Tiger Head Design

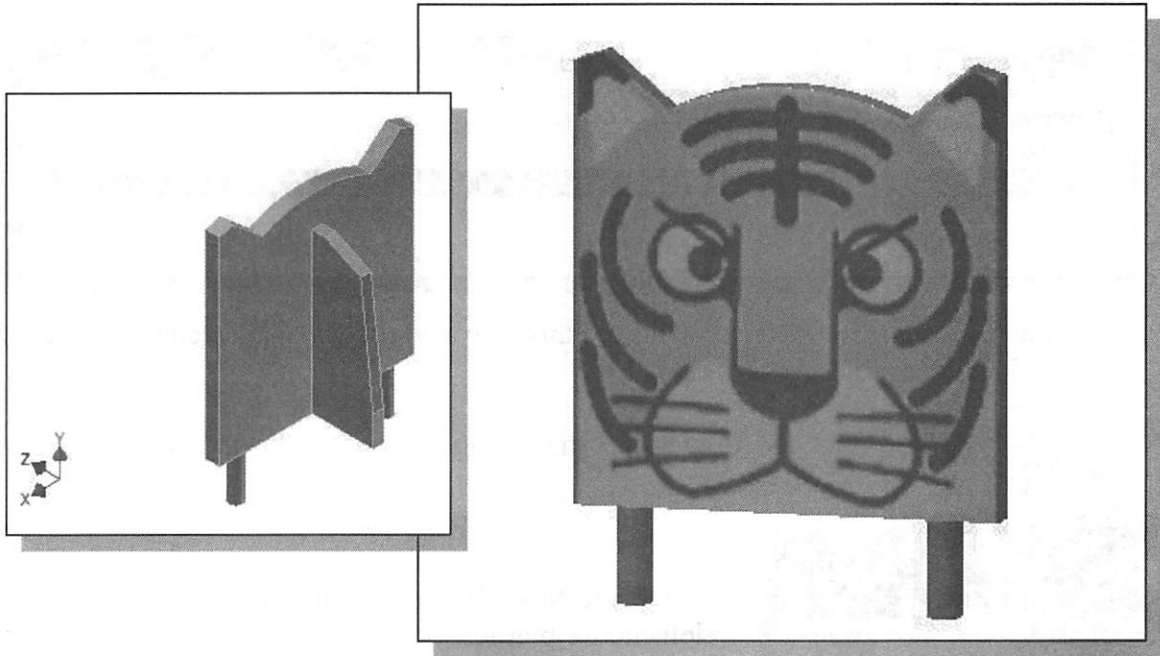

Starting Autodesk Inventor

1. Select the **Autodesk Inventor** option on the *Start* menu or select the **Autodesk Inventor** icon on the desktop to start *Autodesk Inventor*. The *Autodesk Inventor* main window will appear on the screen.

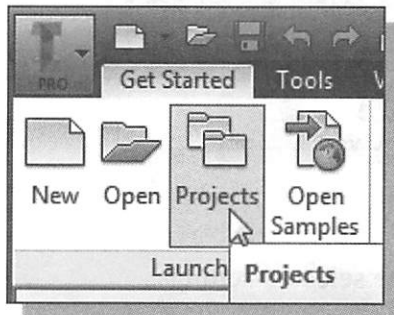

2. Select the **Projects** icon with a single click of the left-mouse-button.

- In the *Projects* list, **double-click** on the *Parametric-Modeling* project name to activate the project as shown.

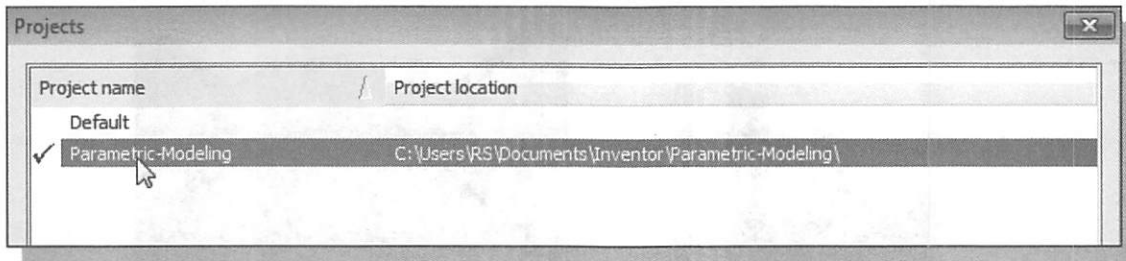

- Note that *Autodesk Inventor* will keep this activated project as the default project until another project is activated.

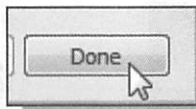

- Click **Done** to accept the setting and end the *Projects Editor*.

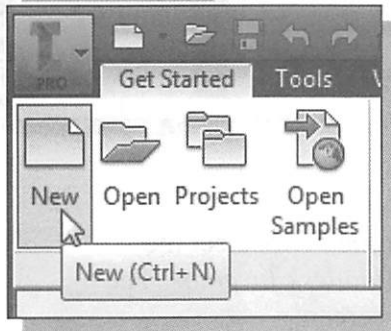

- Select the **New File** icon with a single click of the left-mouse-button.

- Notice the *Parametric-Modeling* project name is displayed as the active project.

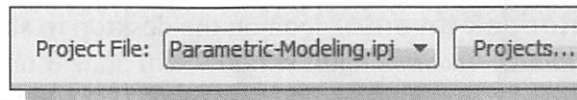

- Select the **English** tab as shown below. When starting a new CAD file, the first thing we should do is choose the units we would like to use. We will use the English setting (inches) for this example.

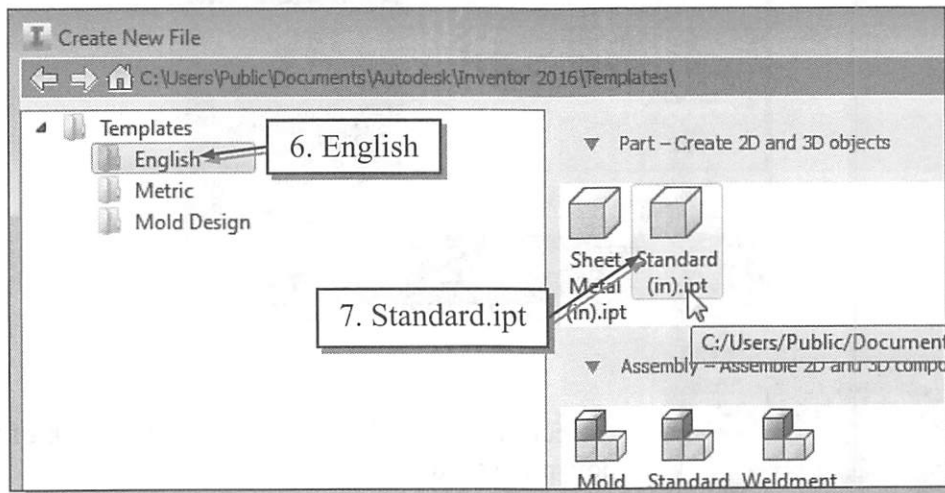

- Select the **Standard(in).ipt** icon as shown.
- Pick **Create** in the *New File* dialog box to accept the selected settings.

The Default *Autodesk Inventor* Screen Layout

The default *Autodesk Inventor* drawing screen contains the *pull-down* menus, the *Standard* toolbar, the *Features* toolbar, the *Sketch* toolbar, the *drawing* area, the *browser* area, and the *Status Bar*. A line of quick text appears next to the icon as you move the *mouse cursor* over different icons. You may resize the *Autodesk Inventor* drawing window by clicking and dragging the edges of the window, or relocate the window by clicking dragging the window title area.

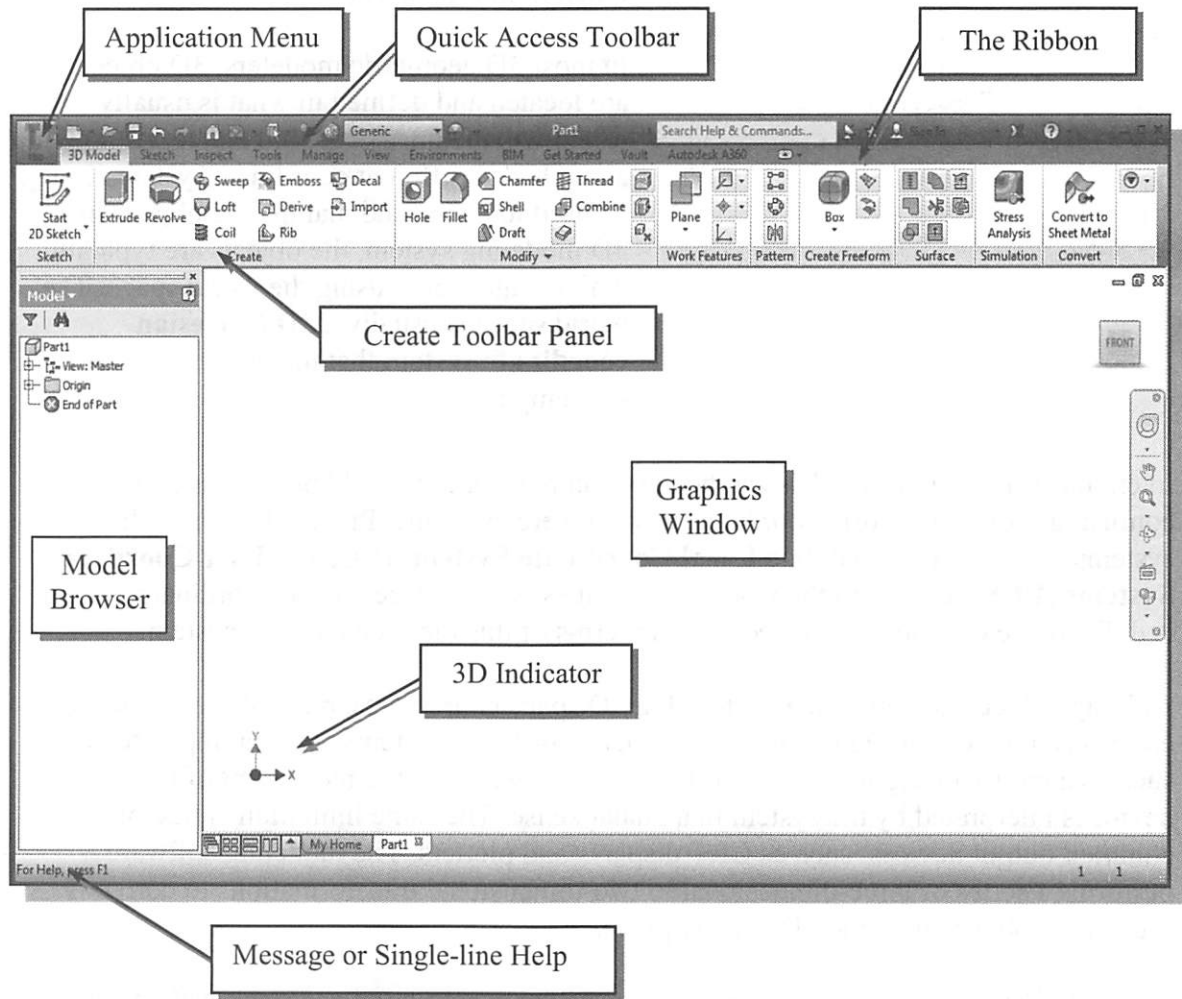

- The **Ribbon** is a new feature in *Autodesk Inventor* since the 2011 release. The **Ribbon** is composed of a series of tool panels, which are organized into tabs labeled by task. The **Ribbon** provides a compact palette of all of the tools necessary to accomplish the different modeling tasks. The drop-down arrow next to any icon indicates additional commands are available on the expanded panel; access the expanded panel by clicking on the drop-down arrow.

Sketch Plane – It is an XY Monitor, but an XYZ World

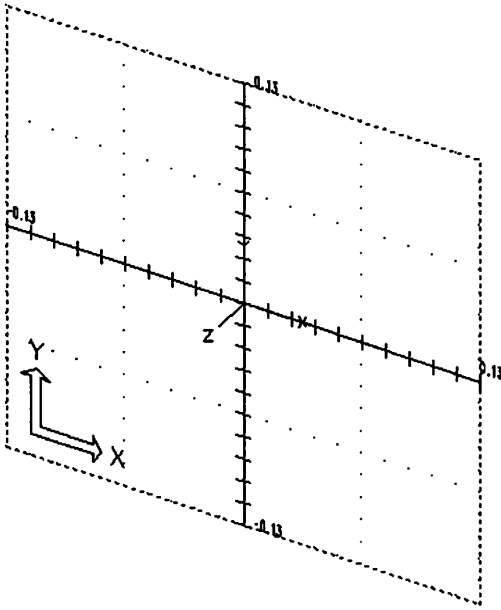

Design modeling software is becoming more powerful and user friendly, yet the system still does only what the user tells it to do. When using a geometric modeler, we therefore need to have a good understanding of what its inherent limitations are.

In most 3D geometric modelers, 3D objects are located and defined in what is usually called **world space** or **global space**. Although a number of different coordinate systems can be used to create and manipulate objects in a 3D modeling system, the objects are typically defined and stored using the world space. The world space is usually a **3D Cartesian coordinate system** that the user cannot change or manipulate.

In engineering designs, models can be very complex, and it would be tedious and confusing if only the world coordinate system were available. Practical 3D modeling systems allow the user to define **Local Coordinate Systems (LCS)** or **User Coordinate Systems (UCS)** relative to the world coordinate system. Once a local coordinate system is defined, we can then create geometry in terms of this more convenient system.

Although objects are created and stored in 3D space coordinates, most of the geometric entities can be referenced using 2D Cartesian coordinate systems. Typical input devices such as a mouse or digitizer are two-dimensional by nature; the movement of the input device is interpreted by the system in a planar sense. The same limitation is true of common output devices, such as CRT displays and plotters. The modeling software performs a series of three-dimensional to two-dimensional transformations to correctly project 3D objects onto the 2D display plane.

The *Autodesk Inventor sketching plane* is a special construction approach that enables the planar nature of the 2D input devices to be directly mapped into the 3D coordinate system. The *sketching plane* is a local coordinate system that can be aligned to an existing face of a part, or a reference plane.

Think of the sketching plane as the surface on which we can sketch the 2D sections of the parts. It is similar to a piece of paper, a white board, or a chalkboard that can be attached to any planar surface. The first sketch we create is usually drawn on one of the established datum planes. Subsequent sketches/features can then be created on sketching planes that are aligned to existing **planar faces of the solid part** or **datum planes**.



1. Activate the **Start 2D Sketch** icon with a single click of the left-mouse-button.

2. Move the cursor over the edge of the *XY Plane* in the graphics area. When the *XY Plane* is highlighted, click once with the **left-mouse-button** to select the *Plane* as the sketch plane for the new sketch.

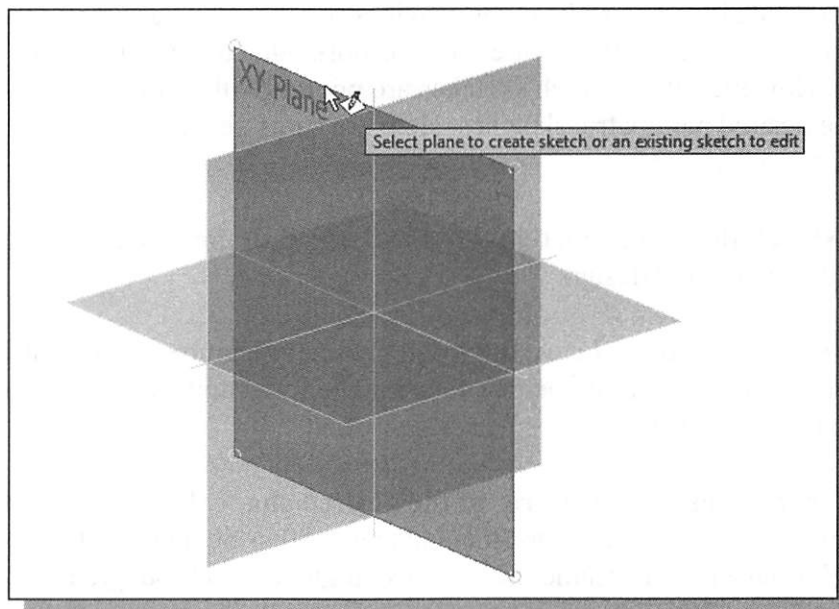

- The *sketching plane* is a reference location where two-dimensional sketches are created. Note that the *sketching plane* can be any planar part surface or datum plane.

3. Confirm the main *Ribbon* area is switched to the **Sketch** toolbars; this indicates we have entered the 2D Sketching mode.

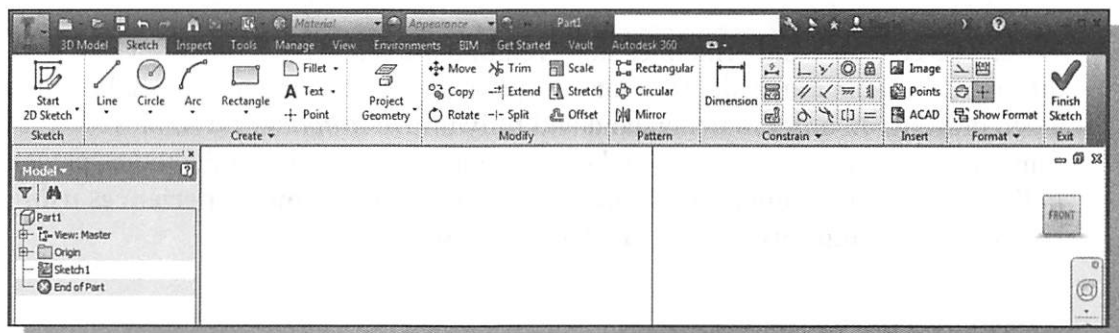

Creating Rough Sketches

Quite often during the early design stage, the shape of a design may not have any precise dimensions. Most conventional CAD systems require the user to input the precise lengths and locations of all geometric entities defining the design, which are not available during the early design stage. With *parametric modeling*, we can use the computer to elaborate and formulate the design idea further during the initial design stage. With *Autodesk Inventor*, we can use the computer as an electronic sketchpad to help us concentrate on the formulation of forms and shapes for the design. This approach is the main advantage of *parametric modeling* over conventional solid-modeling techniques.

As the name implies, a *rough sketch* is not precise at all. When sketching, we simply sketch the geometry so that it closely resembles the desired shape. Precise scale or lengths are not needed. *Autodesk Inventor* provides many tools to assist us in finalizing sketches. For example, geometric entities such as horizontal and vertical lines are set automatically. However, if the rough sketches are poor, it will require much more work to generate the desired parametric sketches. Here are some general guidelines for creating sketches in *Autodesk Inventor*:

- **Create a sketch that is proportional to the desired shape.** Concentrate on the shapes and forms of the design.
 - **Keep the sketches simple.** Leave out small geometry features such as fillets, rounds and chamfers. They can easily be placed using the Fillet and Chamfer commands after the parametric sketches have been established.
 - **Exaggerate the geometric features of the desired shape.** For example, if the desired angle is 85 degrees, create an angle that is 50 or 60 degrees. Otherwise, *Autodesk Inventor* might assume the intended angle to be a 90-degree angle.
 - **Draw the geometry so that it does not overlap.** The geometry should eventually form a closed region. *Self-intersecting* geometry shapes are not allowed.
 - **The sketched geometric entities should form a closed region.** To create a solid feature, such as an extruded solid, a closed region is required so that the extruded solid forms a 3D volume.
- **Note:** The concepts and principles involved in *parametric modeling* are very different, and sometimes they are totally opposite, to those of conventional computer aided drafting. In order to understand and fully utilize *Autodesk Inventor's* functionality, it will be helpful to take a *Zen* approach to learning the topics presented in this text: **Have an open mind and temporarily forget your experiences using conventional Computer Aided Drafting systems.**

Step 1: Creating a Rough Sketch

- The *Sketch* toolbar provides tools for creating the basic geometry that can be used to create features and parts.



1. Move the graphics cursor to the **Line** icon in the *Draw* toolbar. A *Help tip* box appears next to the cursor and a brief description of the command is displayed at the bottom of the drawing screen: “Creates Straight line segments and tangent arcs.”
2. Select the icon by clicking once with the **left-mouse-button**; this will activate the **Line** command. *Autodesk Inventor* expects us to identify the starting location of a straight line.

Graphics Cursors

- Notice the cursor changes from an arrow to a crosshair when graphical input is expected.
1. Move the cursor inside the graphics window, left-click a starting point for the shape, roughly to the left side of the screen as shown.
 2. As you move the graphics cursor, you will see a digital readout next to the cursor and also in the *Status Bar* area at the bottom of the window. The readout gives you the cursor location, the line length, and the angle of the line measured from horizontal. Move the cursor around and you will notice different symbols appear at different locations.

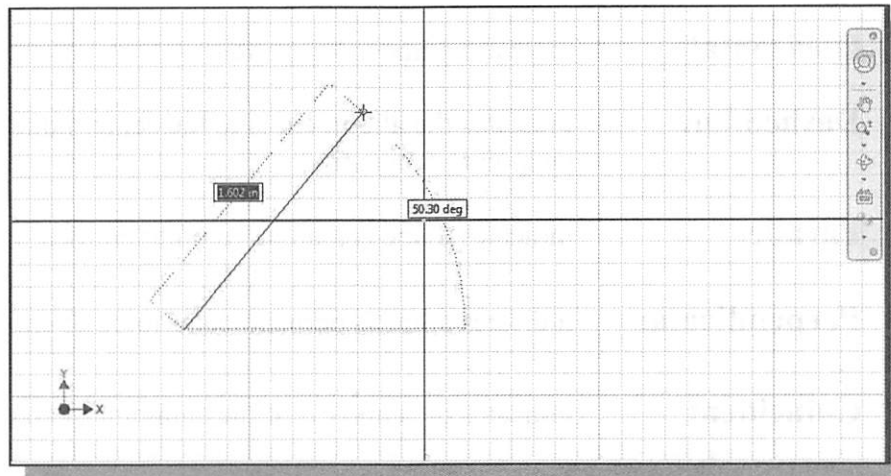

- The readout displayed next to the cursor is called the **Dynamic Input**. This option is part of the **Heads-Up Display** option that is new in *Inventor*. *Dynamic Input* can be used for entering precise values, but its usage is somewhat limited in *parametric modeling*.

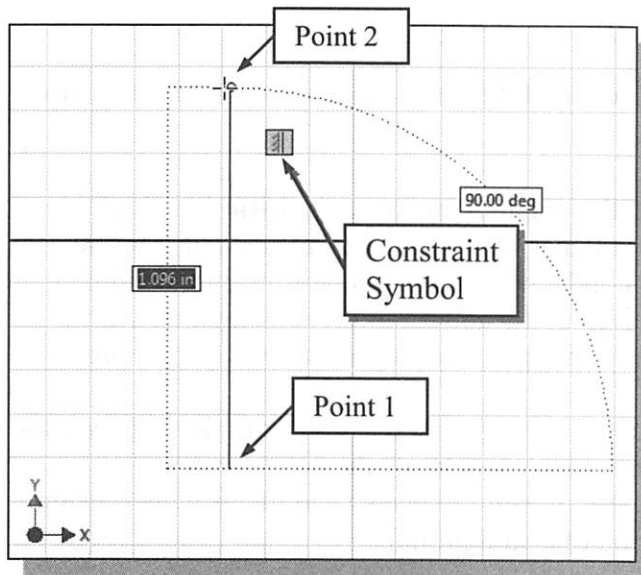

3. Move the graphics cursor above the last point and create a vertical line as shown in the figure (**Point 2**). Notice the geometric constraint symbol, a short vertical line indicating the geometric property, is displayed.

Geometric Constraint Symbols

Autodesk Inventor displays different visual clues, or symbols, to show you alignments, perpendicularities, tangencies, etc. These constraints are used to capture the *design intent* by creating constraints where they are recognized. *Autodesk Inventor* displays the governing geometric rules as models are built. To prevent constraints from forming, hold down the **[Ctrl]** key while creating an individual sketch curve. For example, while sketching line segments with the **Line** command, endpoints are joined with a **Coincident** constraint, but when the **[Ctrl]** key is pressed and held, the inferred constraint will not be created.

	Vertical	indicates a line is vertical
	Horizontal	indicates a line is horizontal
	Dashed line	indicates the alignment is to the center point or endpoint of an entity
	Parallel	indicates a line is parallel to other entities
	Perpendicular	indicates a line is perpendicular to other entities
	Coincident	indicates the cursor is at the endpoint of an entity
	Concentric	indicates the cursor is at the center of an entity
	Tangent	indicates the cursor is at tangency points to curves

1. Complete the sketch as shown below, creating a closed region ending at the starting point (**Point 1**). Do not be overly concerned with the actual size of the sketch. Note that the **four inclined lines** are sketched **not perpendicular or parallel** to each other.

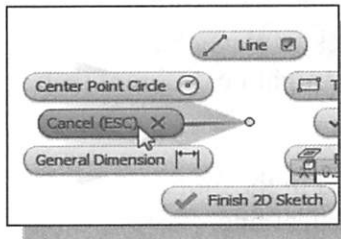
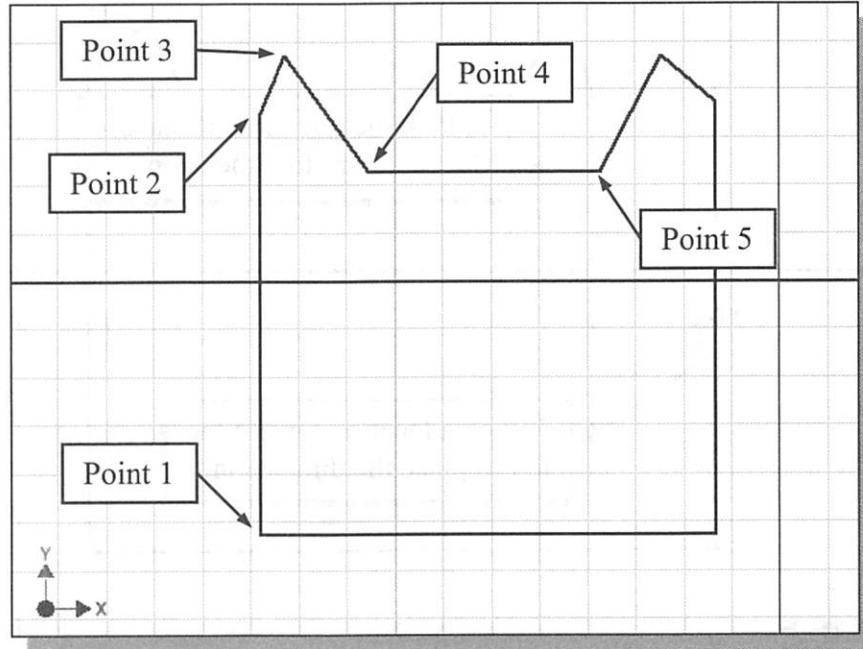

2. Inside the graphics window, click once with the **right-mouse-button** to display the option menu. Select **Cancel [Esc]** in the popup menu, or hit the **[Esc]** key once, to end the Sketch Line command.

Step 2: Apply/Modify Constraints and Dimensions

- As the sketch is made, *Autodesk Inventor* automatically applies some of the geometric constraints (such as horizontal, parallel, and perpendicular) to the sketched geometry. We can continue to modify the geometry, apply additional constraints, and/or define the size of the existing geometry. In this example, we will illustrate adding dimensions to describe the sketched entities.

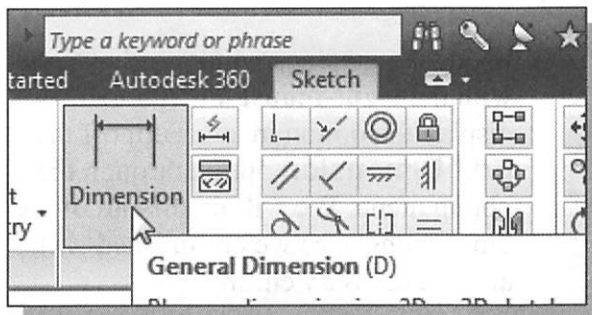

1. Move the cursor to the *Constrain* toolbar area; it is the toolbar next to the 2D *Draw* toolbar. Note the first icon in this toolbar is the **General Dimension** icon. Left-click once on the icon to activate the Dimension command.

- The message “*Select Geometry to Dimension*” is displayed in the *Status Bar* area at the bottom of the *Inventor* window. Select the left vertical line by left-clicking once on the line.

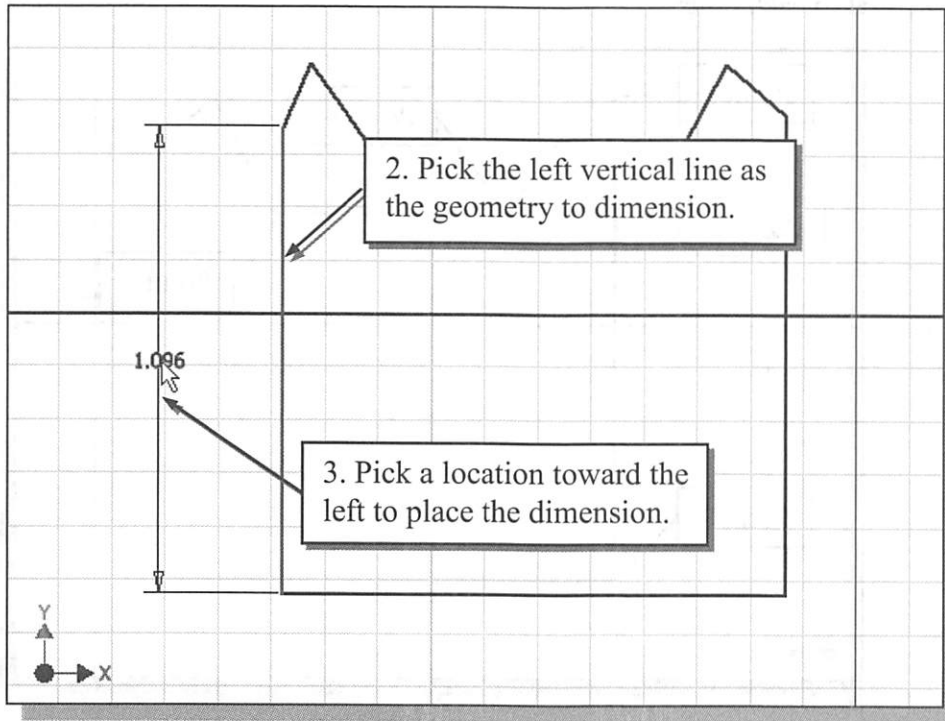

- Move the graphics cursor toward the left side and left-click to place the dimension. (Note that the value displayed on your screen might be different than what is shown in the figure above.)
 - The message “*Select Geometry to Dimension*” is displayed in the *Status Bar* area, at the bottom of the *Inventor* window. Select the right-vertical line.
 - Pick a location toward the right of the sketch to place the dimension.
 - Click **OK** to accept the default value for the dimension.
- The General Dimension command will create a length dimension if a single line is selected.

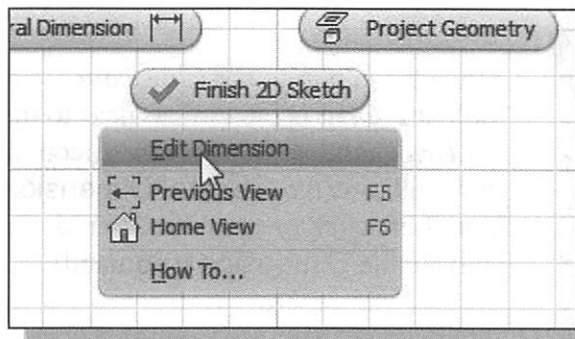

- Inside the graphics window, click once with the **right-mouse-button** to display the option menu. Turn off the **Edit Dimension** option through the popup menu. We will modify all of the dimensions once we are finished with all the necessary editing.

8. The message “*Select Geometry to Dimension*” is displayed in the *Status Bar* area, located at the bottom of the *Inventor* window. Select the left vertical line as shown below.
9. Select the right vertical line as shown below.

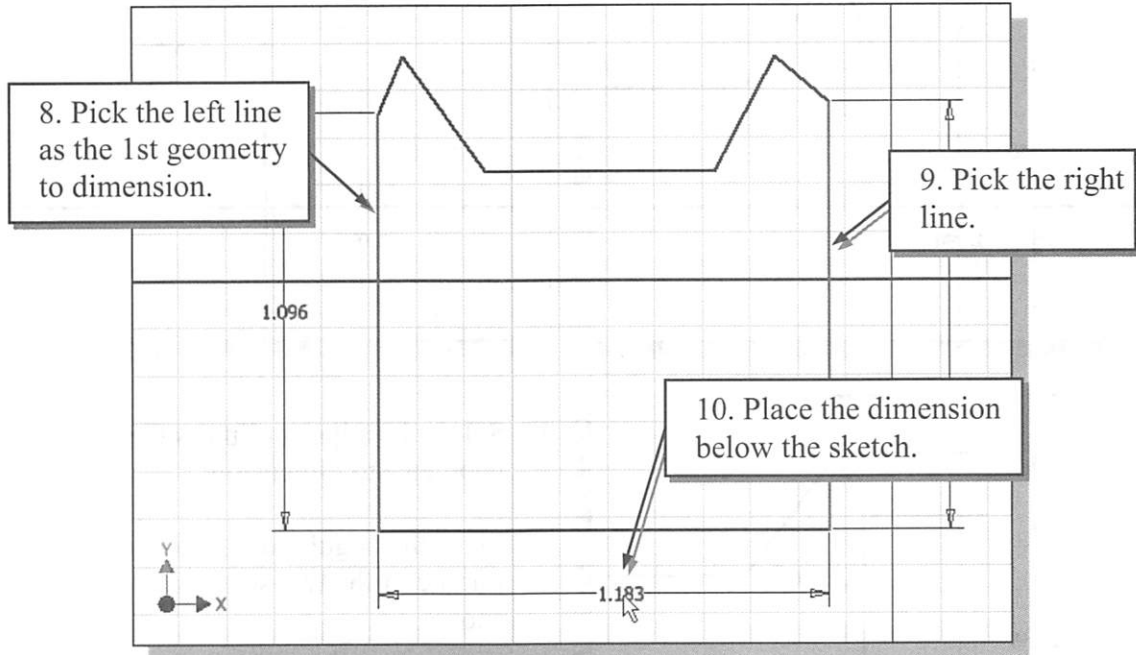

10. Pick a location below the sketch to place the dimension.
11. The message “*Select Geometry to Dimension*” is displayed in the *Status Bar* area, located at the bottom of the *Inventor* window. Select the top left corner as shown.

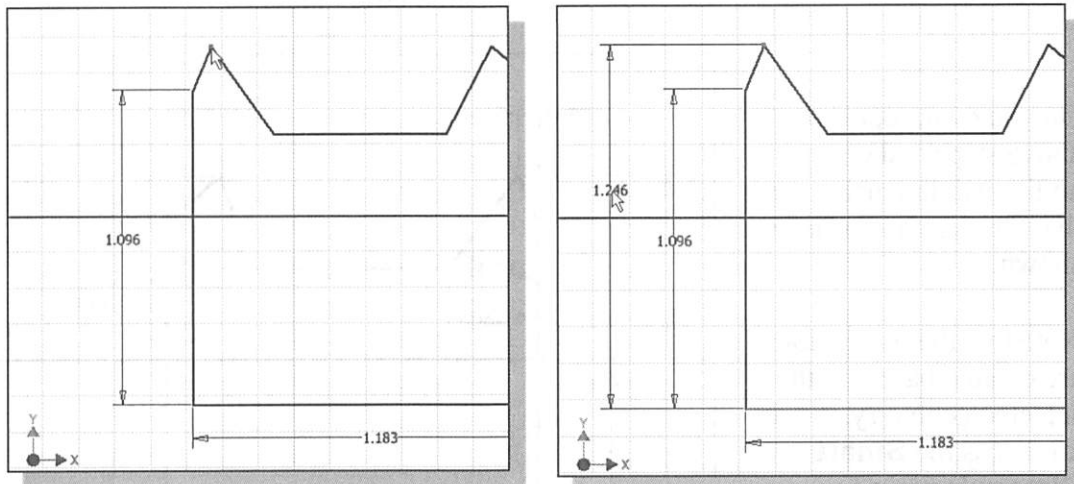

12. Select the bottom horizontal line as the 2nd geometry to dimension.
13. Place the dimension toward the left of the sketch as shown.

14. The message “*Select Geometry to Dimension*” is displayed in the *Status Bar* area, located at the bottom of the *Inventor* window. Select the left vertical line as shown.

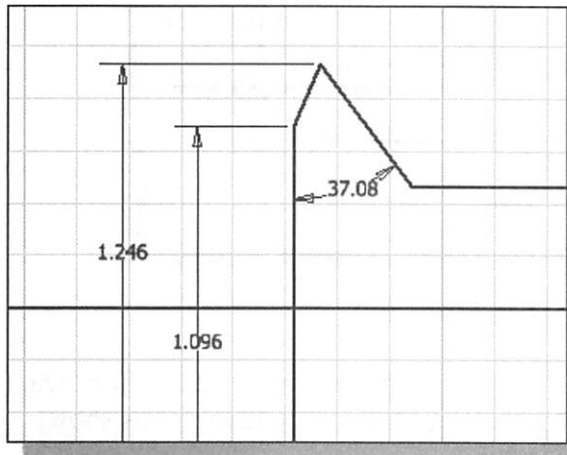
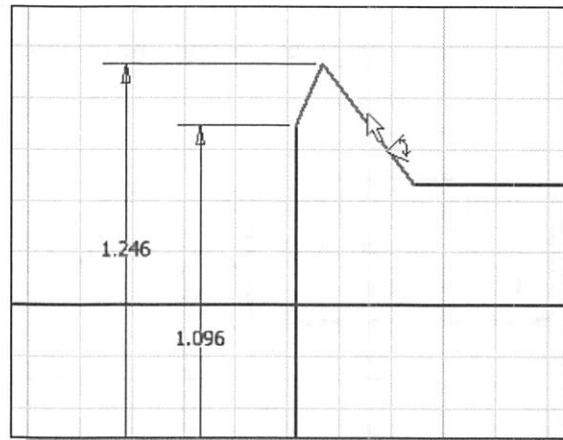
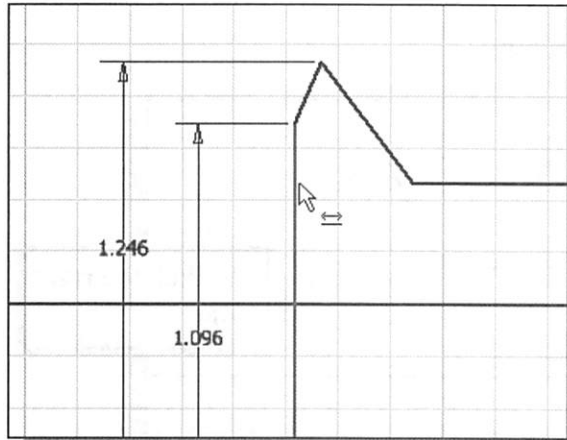

15. Select the adjacent line as the 2nd geometry to dimension.

16. Place the angular dimension in the middle of the two selected lines as shown

❖ Based on selected entities, the **General Dimension** command will create associated dimensions; this is also known as **Smart Dimensioning** in parametric modeling.

17. On you own, repeat the above steps and create additional dimensions so that the sketch appears as shown.

- Note that the dimensions are created based on the selected geometry, this is known as the **Smart Dimensioning** feature in *parametric modeling*.

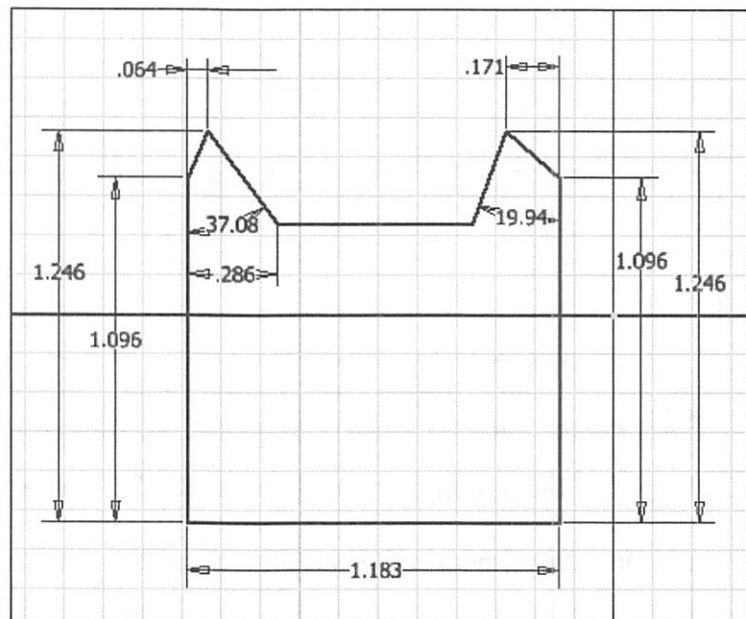

Dynamic Viewing Functions – Zoom and Pan

- *Autodesk Inventor* provides a special user interface called *Dynamic Viewing* that enables convenient viewing of the entities in the graphics window.

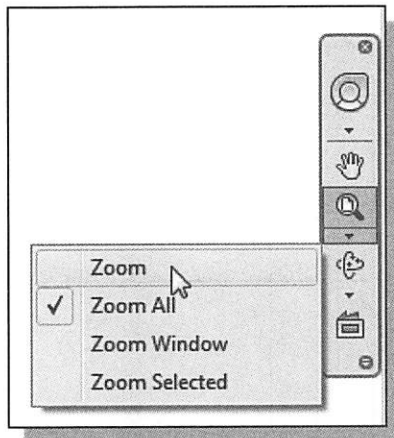

1. Click on the **Zoom** icon, located in the *Navigation* bar as shown.
2. Move the cursor near the center of the graphics window.
3. Inside the graphics window, **press and hold down the left-mouse-button**, then move downward to enlarge the current display scale factor.
4. Press the [**Esc**] key once to exit the ZOOM command.

5. Click on the **Pan** icon located above the ZOOM command in the *Navigation* bar. The icon is the picture of a hand.

- The **Pan** command enables us to move the view to a different position. This function acts as if you are using a video camera.

6. On your own, use the ZOOM and Pan options to reposition the sketch near the center of the screen.

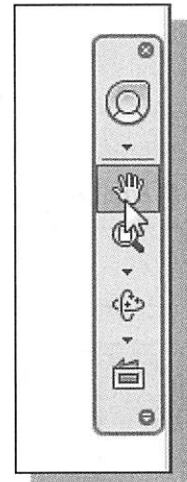

Modifying the Dimensions of the Sketch

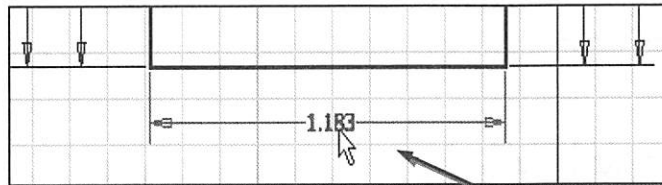

1. Select the dimension that is at the bottom of the sketch by **double-clicking** on the dimension text.

1. Select this dimension to modify.

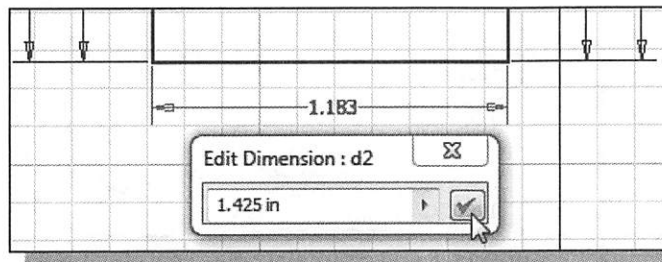

2. In the *Edit Dimension* window, the current length of the line is displayed. Enter **1.425** to set the length of the line.
3. Click on the **Accept** icon to accept the entered value.

➤ *Autodesk Inventor* will now update the profile with the new dimension value.

4. On your own, repeat the above steps and adjust the dimensions so that the sketch appears as shown.

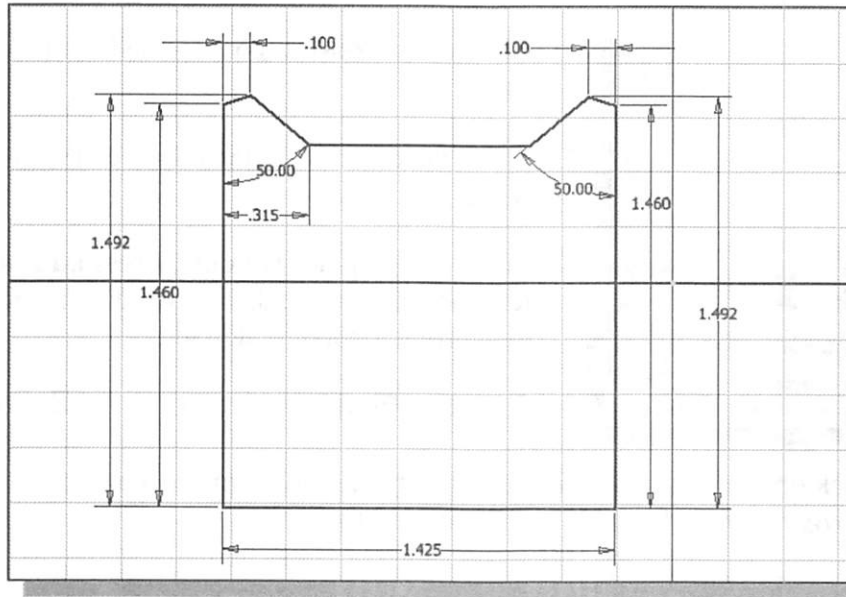

Delete an Existing Geometry of the Sketch

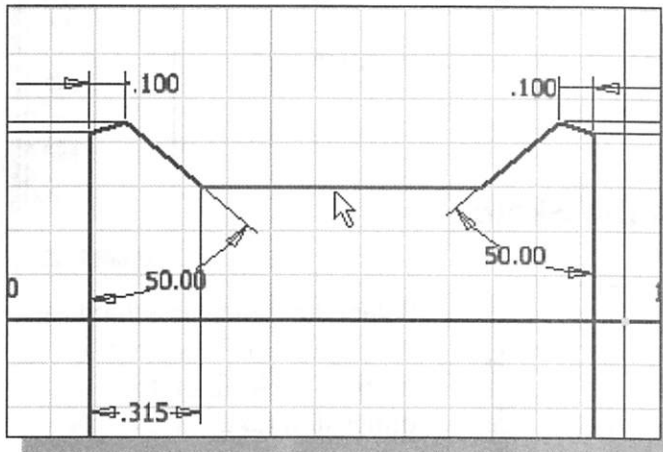

1. Select the top horizontal line by **left-clicking** once on the line.

2. Click once with the right-mouse-button to bring up the **option menu**.
3. Select **Delete** from the *option list* as shown.

➤ Note that any dimension attached to the geometry will be also deleted.

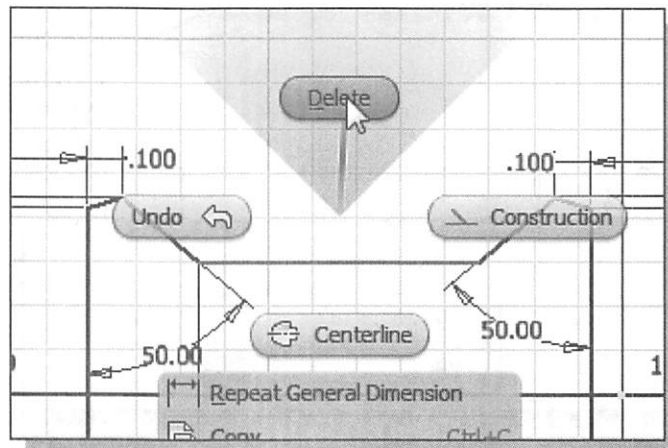

Using the 3-Point Arc Command

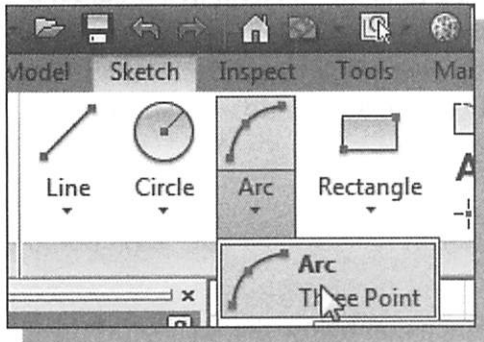

1. Select the **Three Point Arc** command in the *Draw* toolbar as shown.

- Note the **Three Point Arc** command requires defining the end point locations first.

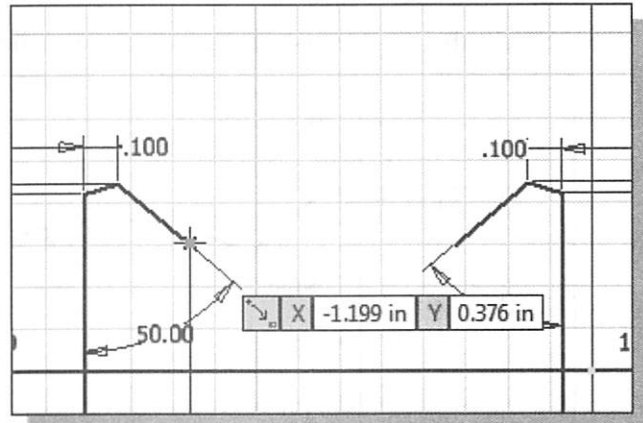

2. Select the endpoint of the longer inclined line on the left as shown.

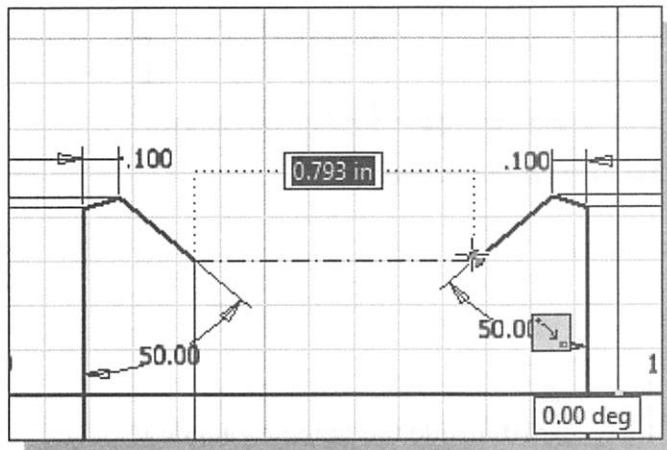

3. Select the endpoint of the longer inclined line on the right as shown.

4. Move the cursor above the two selected points to set the curvature of the arc, **left-clicking** once when the radius is curved upward as shown.

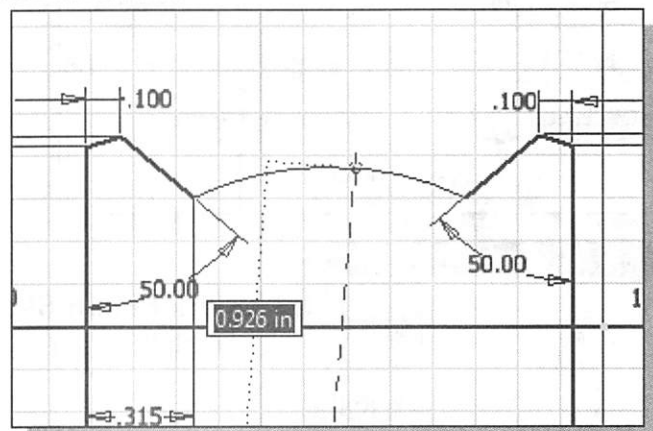

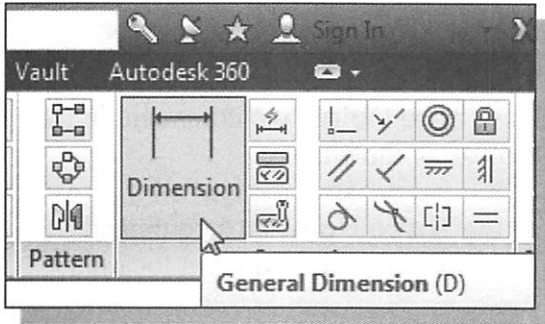

5. Left-click once on the icon to activate the General Dimension command. The *General Dimension* command allows us to quickly create and modify dimensions.

6. Select the arc we just created, and place the dimension below the arc.

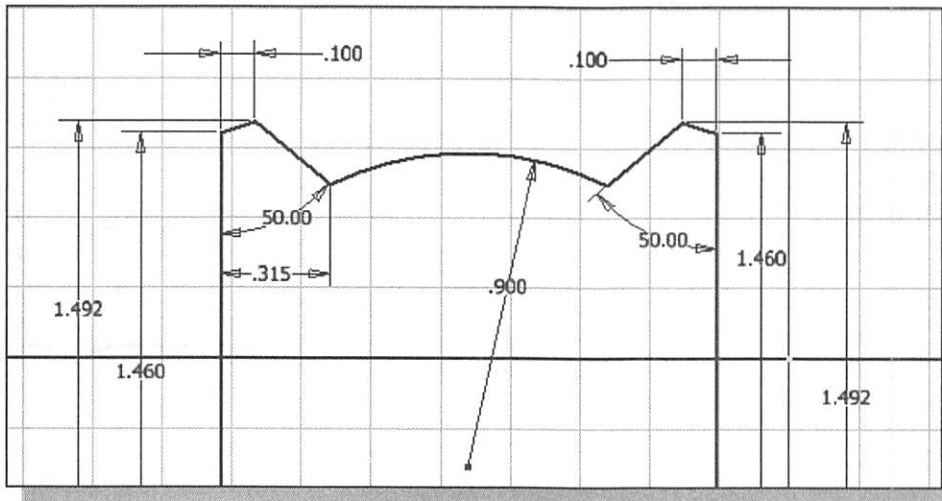

7. Click on the radius dimension text to enter the *edit mode*.

8. Enter **0.90** as the new radius as shown.

9. Click **OK** to accept the setting.

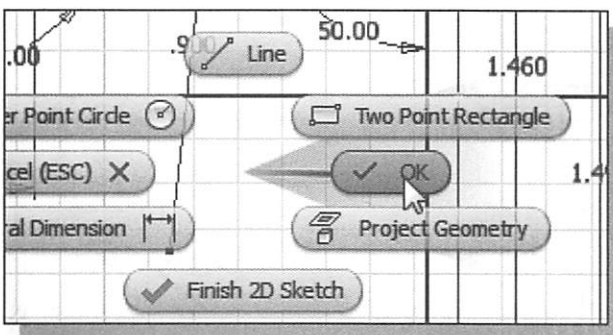

10. Inside the graphics window, click once with the **right-mouse-button** to display the option menu. Select **OK** in the popup menu to end the Sketch Line command.

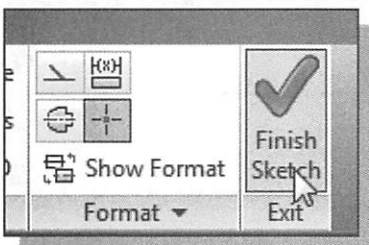

11. Click **Finish Sketch** in the *Exit* toolbar to end the Sketch option.

Step 3: Completing the Base Solid Feature

Now that the 2D sketch is completed, we will proceed to the next step: create a 3D part from the 2D profile. Extruding a 2D profile is one of the common methods that can be used to create 3D parts. We can extrude planar faces along a path. We can also specify a height value and a tapered angle. In *Autodesk Inventor*, each face has a positive side and a negative side; the current face we're working on is set as the default positive side. This positive side identifies the positive extrusion direction and it is referred to as the face's *normal*.

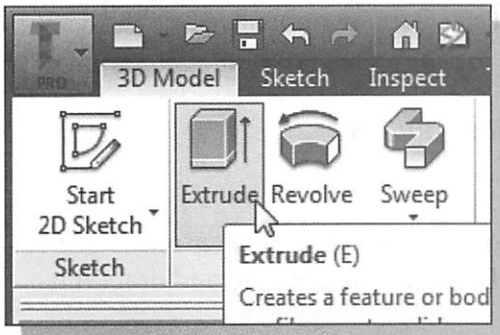

1. In the 3D Model tab (the tab is located in the *Ribbon*) select the **Extrude** command by clicking the left-mouse-button on the icon.

2. In the *Extrude* popup window, expand the window by clicking on the down arrow; enter **0.1** as the extrusion distance. Notice that the sketch region is automatically selected as the extrusion profile.

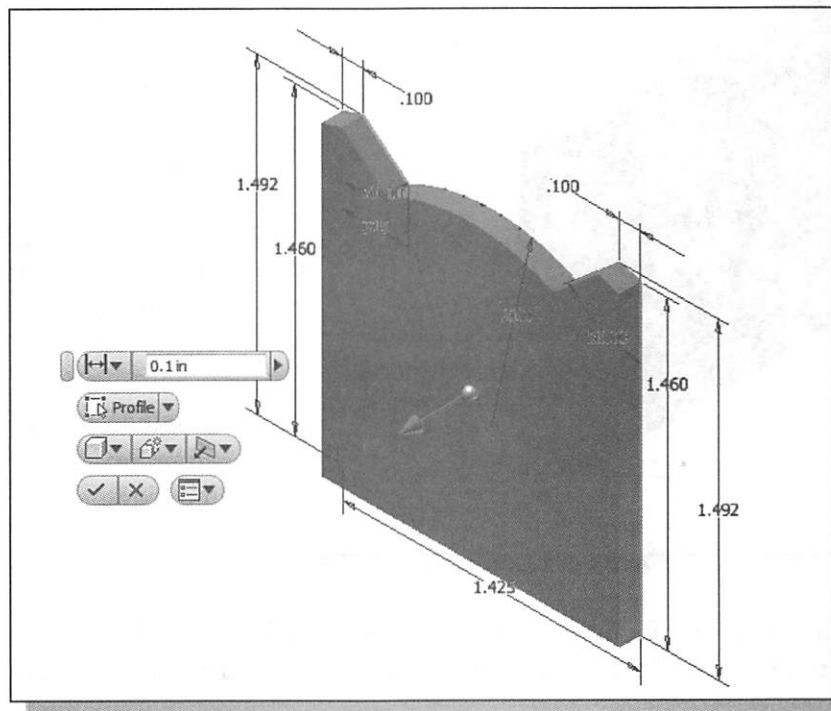

3. Click on the **OK** button to proceed with creating the 3D part.
- Note that all dimensions disappeared from the screen. All parametric definitions are stored in the *Autodesk Inventor* database and any of the parametric definitions can be re-displayed and edited at any time.

Dynamic Rotation of the 3D Block – *Free Orbit*

The *Free Orbit* command allows us to:

- Orbit a part or assembly in the graphics window. Rotation can be around the center mark, free in all directions, or around the *X/Y*-axes in the *3D-Orbit* display.
- Reposition the part or assembly in the graphics window.
- Display isometric or standard orthographic views of a part or assembly.
- The *Free Orbit* tool is accessible while other tools are active. *Autodesk Inventor* remembers the last used mode when you exit the *Orbit* command.

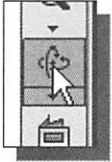

1. Click on the **Free Orbit** icon in the *Navigation* bar.

- The *3D Orbit* display is a circular rim with four handles and a center mark. *3D Orbit* enables us to manipulate the view of 3D objects by clicking and dragging with the left-mouse-button:

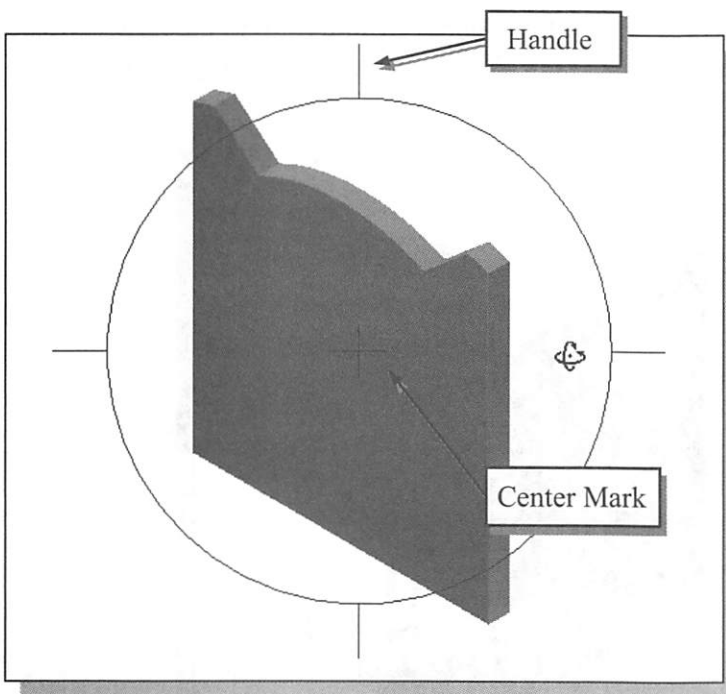

- Drag with the left-mouse-button near the center for free rotation.
- Drag on the handles to orbit around the horizontal or vertical axis.
- Drag on the rim to orbit about an axis that is perpendicular to the displayed view.
- Single left-mouse-click to align the center mark of the view.

2. Inside the *circular rim*, press down the left-mouse-button and drag in an arbitrary direction; the *3D Orbit* command allows us to freely orbit the solid model.
3. Move the cursor near the circular rim and notice the cursor symbol changes to a single circle. Drag with the left-mouse-button to orbit about an axis that is perpendicular to the displayed view.
4. Single left-mouse-click near the top handle to align the selected location to the center mark in the graphics window.

5. Activate the **Constrained Orbit** option by clicking on the associated icon as shown.

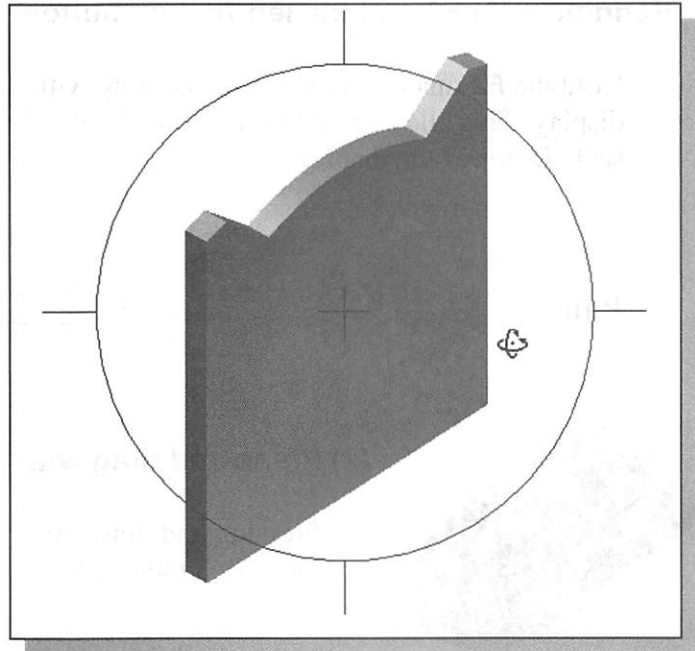
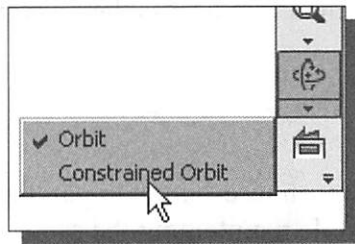

- ❖ *The Constrained Orbit can be used to rotate the model about axes in Model Space, equivalent to moving the eye position about the model in latitude and longitude.*

6. On your own, use the different options described in the above steps and familiarize yourself with both of the 3D Orbit commands. Reset the display to the *Isometric* view as shown in the figure above before continuing to the next section.

- ❖ Note that while in the 3D Orbit mode, a horizontal marker will be displayed next to the cursor if the cursor is away from the circular rim. This is the **exit marker**. Left-clicking once will allow you to exit the 3D Orbit command.

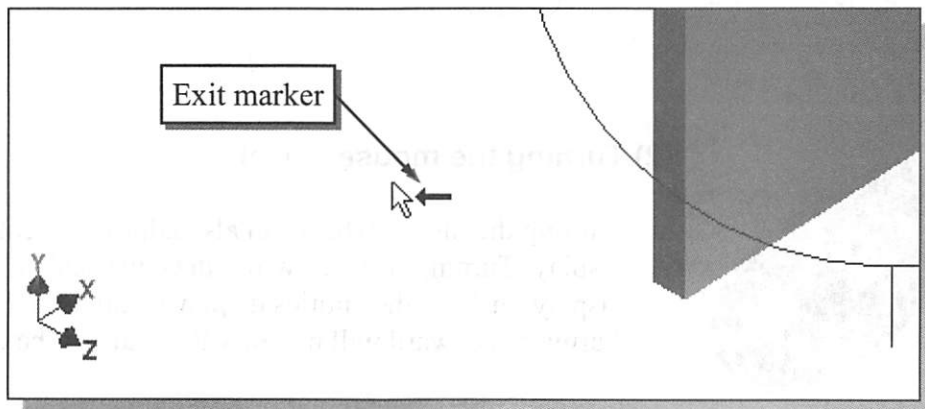

Dynamic Viewing – Quick Keys

We can also use the function keys on the keyboard and the mouse to access the *Dynamic Viewing* functions.

❖ Panning – (1) F2 and the left-mouse-button

Hold the **F2** function key down, and drag with the left-mouse-button to pan the display. This allows you to reposition the display while maintaining the same scale factor of the display.

Pan

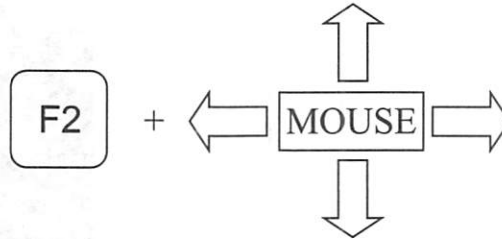

(2) Press and drag with the mouse wheel

Pressing and dragging with the mouse wheel can also reposition the display.

❖ Zooming – (1) F3 and drag with the left-mouse-button

Hold the **F3** function key down, and drag with the left-mouse-button vertically on the screen to adjust the scale of the display. Moving upward will reduce the scale of the display, making the entities display smaller on the screen. Moving downward will magnify the scale of the display.

Zoom

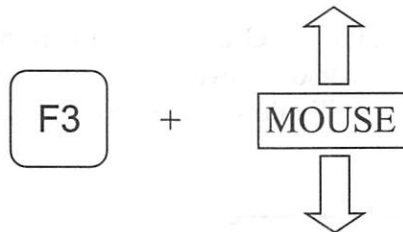

(2) Turning the mouse wheel

Turning the mouse wheel can also adjust the scale of the display. Turning forward will reduce the scale of the display, making the entities display smaller on the screen. Turning backward will magnify the scale of the display.

❖ 3D Dynamic Rotation – F4 and the left-mouse-button

Hold the **F4** function key down and drag with the left-mouse-button to orbit the display. The 3D Orbit rim with four handles and the center mark appear on the screen. Note that the Common View option is not available when using the **F4** quick key.

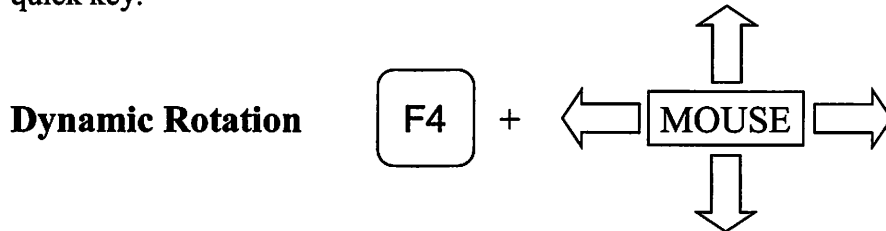

Viewing Tools – Standard Toolbar

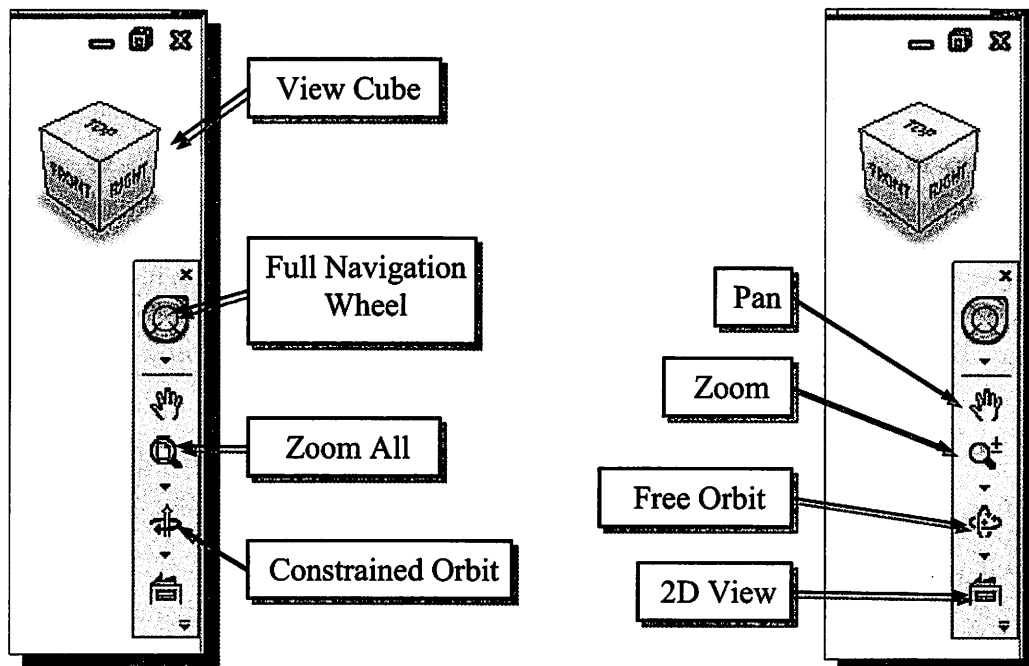

Zoom All – Adjusts the view so that all items on the screen fit inside the graphics window.

Zoom Window – Use the cursor to define a region for the view; the defined region is zoomed to fill the graphics window.

Zoom – Moving upward will reduce the scale of the display, making the entities display smaller on the screen. Moving downward will magnify the scale of the display.

Pan – This allows you to reposition the display while maintaining the same scale factor of the display.

Zoom Selected – In a part or assembly, zooms the selected edge, feature, line, or other element to fill the graphics window. You can select the element either before or after clicking the Zoom button. (Not used in drawings.)

Orbit – In a part or assembly, adds an orbit symbol and cursor to the view. You can orbit the view planar to the screen around the center mark, around a horizontal or vertical axis, or around the X and Y axes. (Not used in drawings.)

2D View/View Face – In a part or assembly, zooms and orbits the model to display the selected element planar to the screen or a selected edge or line horizontal to the screen. (Not used in drawings.)

View Cube – The ViewCube is a 3D navigation tool that appears, by default, when you enter *Inventor*. The ViewCube is a clickable interface which allows you to switch between standard and isometric views.

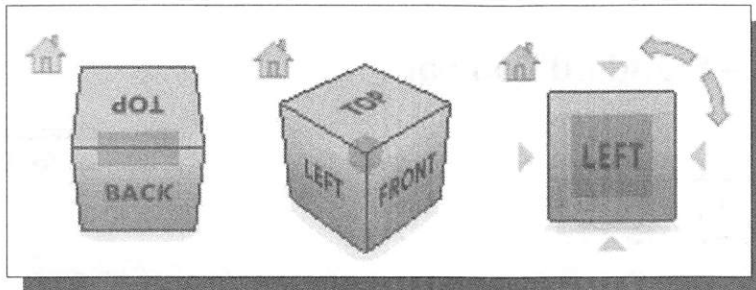

Once the ViewCube is displayed, it is shown in one of the corners of the graphics window over the model in an inactive state. The ViewCube also provides visual feedback about the current viewpoint of the model as view changes occur. When the cursor is positioned over the ViewCube, it becomes active and allows you to switch to one of the available preset views, roll the current view, or change to the Home view of the model.

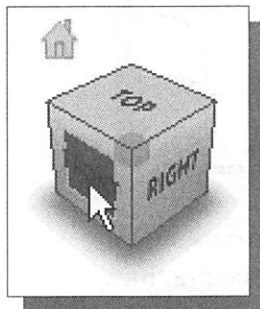

1. Move the cursor over the ViewCube and notice the different sides of the ViewCube become highlighted and can be activated.
2. Single left-mouse-click when the front side is activated as shown. The current view is set to view the front side.

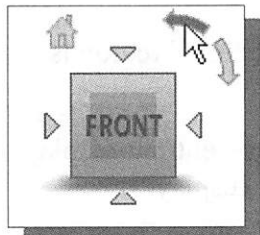

3. Move the cursor over the counter-clockwise arrow of the ViewCube and notice the orbit option becomes highlighted.
4. Single left-mouse-click to activate the counter-clockwise option as shown. The current view is orbited 90 degrees; we are still viewing the front side.

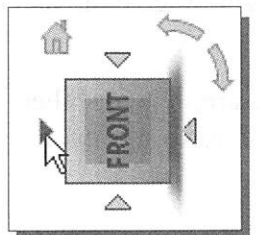

5. Move the cursor over the left arrow of the ViewCube and notice the orbit option becomes highlighted.

6. Single left-mouse-click to activate the left arrow option as shown. The current view is now set to view the top side.

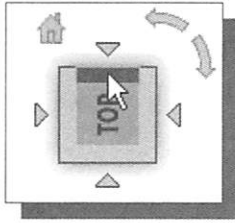

7. Move the cursor over the top edge of the ViewCube and notice the roll option becomes highlighted.

8. Single left-mouse-click to activate the roll option as shown. The view will be adjusted to roll 45 degrees.

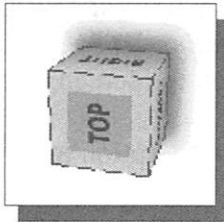

9. Move the cursor over the ViewCube and drag with the left-mouse-button to activate the **Free Rotation** option.

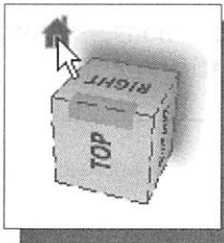

10. Move the cursor over the home icon of the ViewCube and notice the Home View option becomes highlighted.

11. Single left-mouse-click to activate the **Home View** option as shown. The view will be adjusted back to the default *isometric view*.

Full Navigation Wheel – The Navigation Wheel contains tracking menus that are divided into different sections known as wedges. Each wedge on the wheel represents a single navigation tool. You can pan, zoom, or manipulate the current view of a model in different ways. The 3D Navigation Wheel and 2D Navigation Wheel (mostly used in the 2D drawing mode) have some or all of the following options:

Zoom – Adjusts the magnification of the view.

Center – Centers the view based on the position of the cursor over the wheel.

Rewind – Restores the previous view.

Forward – Increases the magnification of the view.

Orbit – Allows 3D free rotation with the left-mouse-button.

Pan – Allows panning by dragging with the left-mouse-button.

Up/Down – Allows panning with the use of a scroll control.

Walk – Allows *walking*, with linear motion perpendicular to the screen, through the model space.

Look – Allows rotation of the current view vertically and horizontally.

3D Full Navigation Wheel

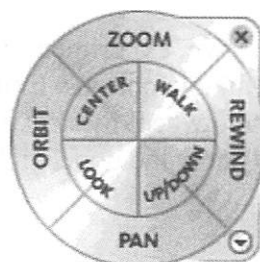

2D Full Navigation Wheel

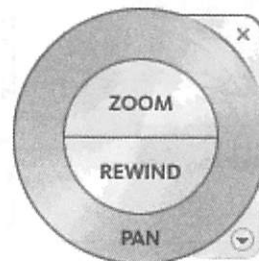



1. Activate the **Full Navigation Wheel** by clicking on the icon as shown.

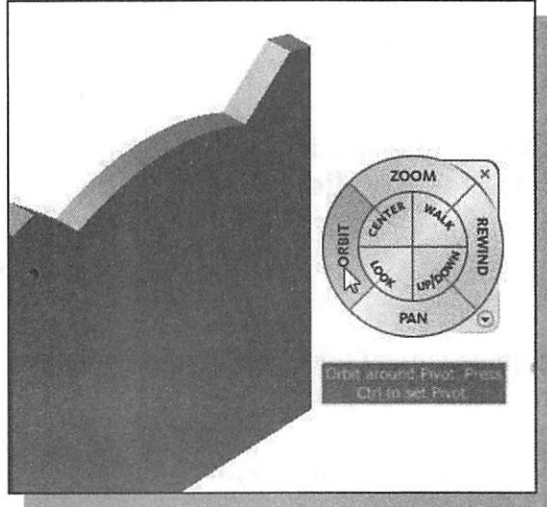

2. Move the cursor in the graphics window and notice the *Full Navigation Wheel* menu follows the cursor on the screen.
3. Move the cursor on the Orbit option to highlight the option.
4. Click and drag with the left-mouse-button to activate the **Free Rotation** option.

5. Drag with the left-mouse-button and notice the ViewCube also reflects the model orientation.

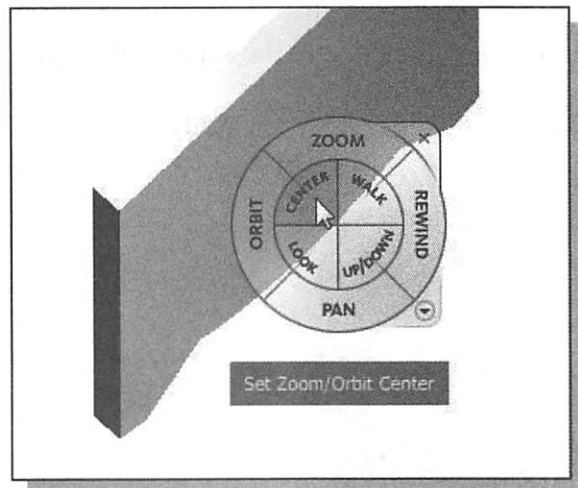
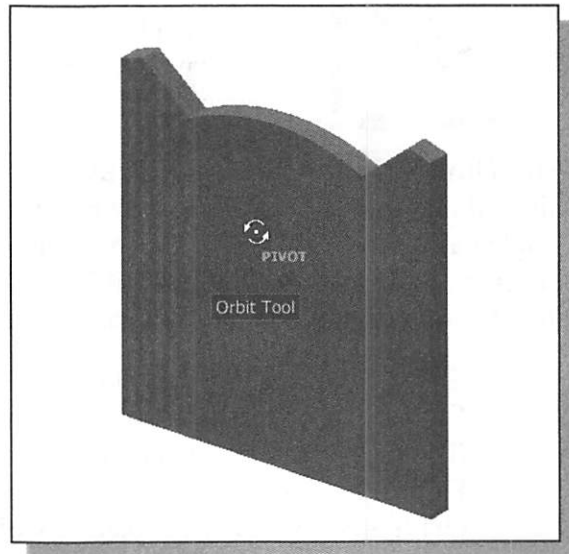

6. Move the cursor to the left side of the model and click the **Center** option as shown. The display is adjusted so the selected point is the new **Zoom/Orbit** center.
7. On your own, experiment with the other available options. Exit the Navigation wheel by clicking on the small [x] near the upper right corner.

Display Modes



- The **Visual Style** command in the *View* tab has ten display modes ranging from very realistic renderings of the model to very artistic representations of the model. The more commonly used modes are as follows:

❖ Realistic Shaded Solid:

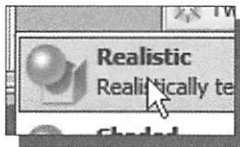

The *Realistic Shaded Solid* display mode generates a high quality shaded image of the 3D object.

❖ Standard Shaded Solid:

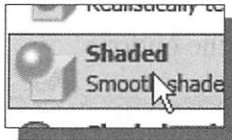

The *Standard Shaded Solid* display option generates a shaded image of the 3D object that requires fewer computer resources compared to the realistic rendering.

❖ Wireframe Image:

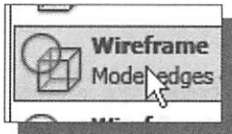

The *Wireframe Image* display option allows the display of the 3D objects using the basic wireframe representation scheme.

❖ Wireframe with Hidden-Edge Display:

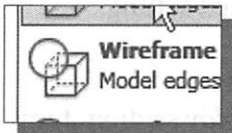

The *Wireframe with Hidden-Edge Display* option can be used to generate an image of the 3D object with all the back lines hidden.

Orthographic vs. Perspective

- Besides the three basic display modes, we can also choose orthographic view or perspective view of the display. Click on the icon next to the display mode button on the *Standard* toolbar, as shown in the figure.

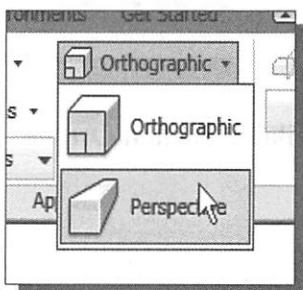

❖ Orthographic

The first icon allows the display of the 3D object using the parallel edges representation scheme.

❖ Perspective

The second icon allows the display of the 3D object using the perspective, nonparallel edges representation scheme.

Disable the Heads-Up Display Option

- The **Heads-Up Display** option in *Inventor* provides mainly the **Dynamic Input** function, which can be quite useful for 2D drafting activities. For example, in the use of a 2D drafting CAD system, most of the dimensions of the design would have been determined by the documentation stage. However, in *parametric modeling*, the usage of the *Dynamic Input* option is quite limited, as this approach does not conform to the “**shape before size**” design philosophy.

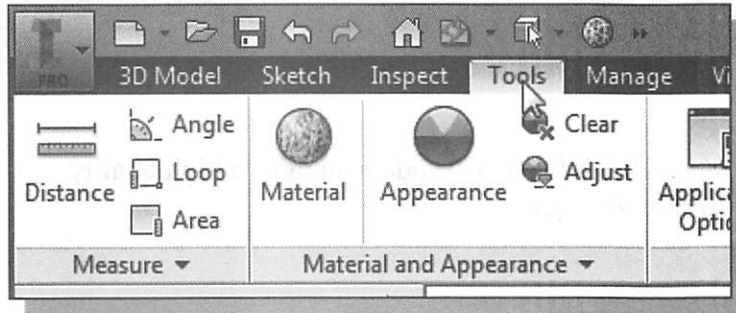

1. Select the **Tools** tab in the *Ribbon* as shown.

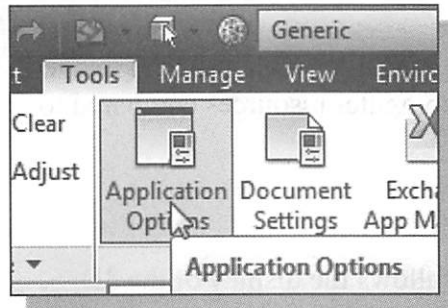

2. Select **Application Options** in the options toolbar as shown.

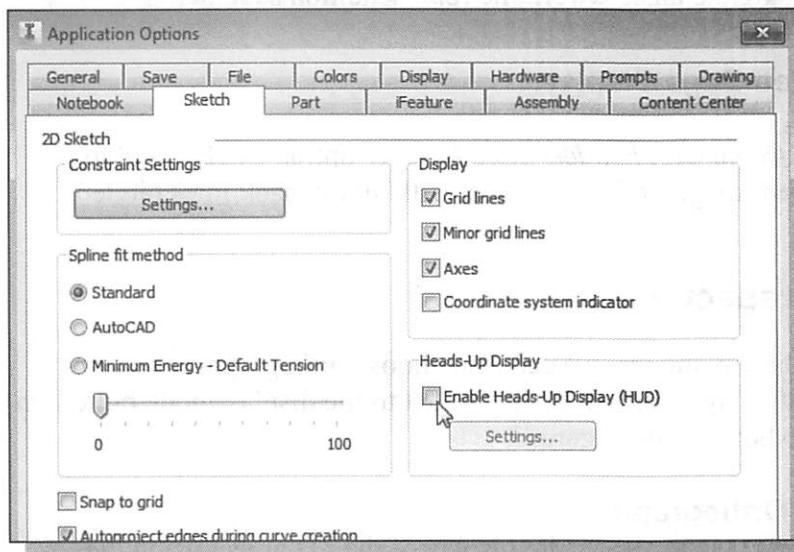

3. Pick the **Sketch** tab to display the sketch related settings.
4. In the *Heads-Up Display* section, turn **OFF** the **Enable Heads-Up Display** option as shown.
5. Switch on the **Grid lines** display

6. On your own, examine the other sketch settings that are available; switch **On** the *Grid lines* in the *Display* section.

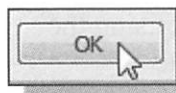

7. Click **OK** to accept the settings.

Step 4-1: Adding an Extruded Feature

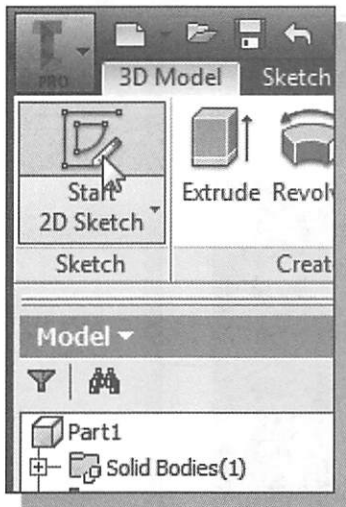

1. Activate the **3D Model** tab and select the **Start 2D Sketch** command by left-clicking once on the icon.
2. In the *Status Bar* area, the message: “*Select face, workplane, sketch or sketch geometry*” is displayed. *Autodesk Inventor* expects us to identify a planar surface where the 2D sketch of the next feature is to be created. Move the graphics cursor on the 3D part and notice that *Autodesk Inventor* will automatically highlight feasible planes and surfaces as the cursor is on top of the different surfaces. Pick the back face of the 3D solid object.

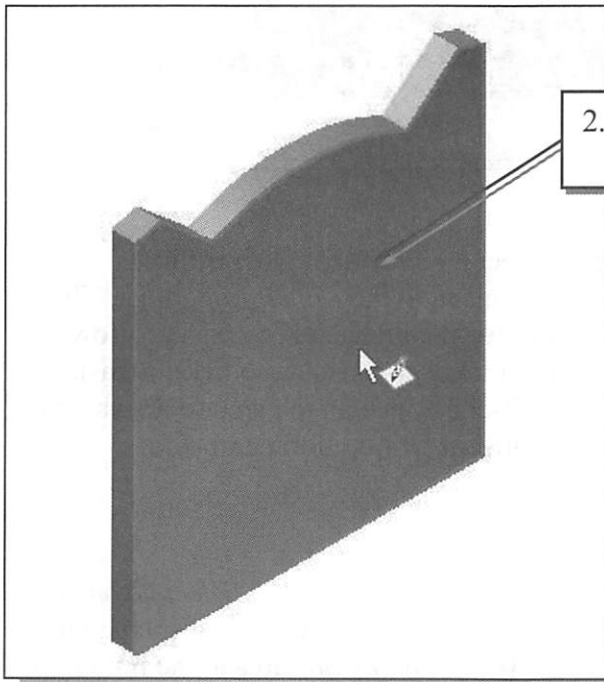

2. Pick the back face of the solid.

- Note that the sketch plane is aligned to the selected face. *Autodesk Inventor* automatically establishes a *User Coordinate System (UCS)* and records its location with respect to the part on which it was created.

- Next, we will create and profile another sketch, a rectangle, which will be used to create another extrusion feature that will be added to the existing solid object.

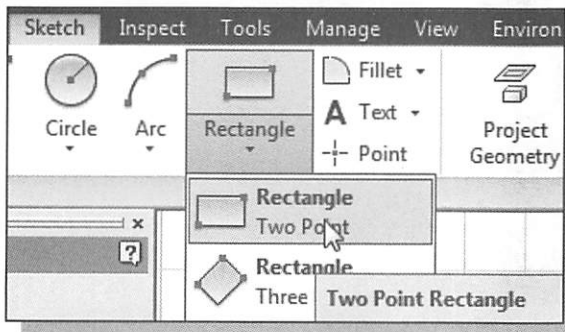

3. Select the **Rectangle** command by clicking once with the **left-mouse-button** on the icon in the *Draw* toolbar.

- To illustrate the usage of dimensions in parametric sketches, we will intentionally create a rectangle away from the desired location.

4. Create a sketch with segments perpendicular/parallel to the bottom edges of the solid model as shown below.

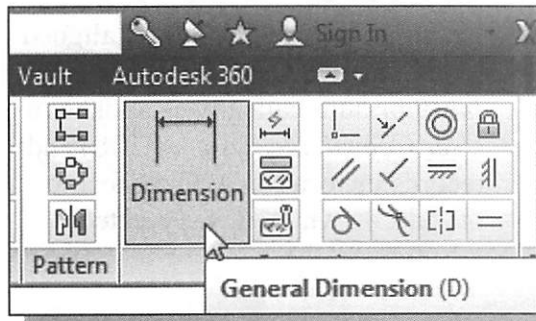
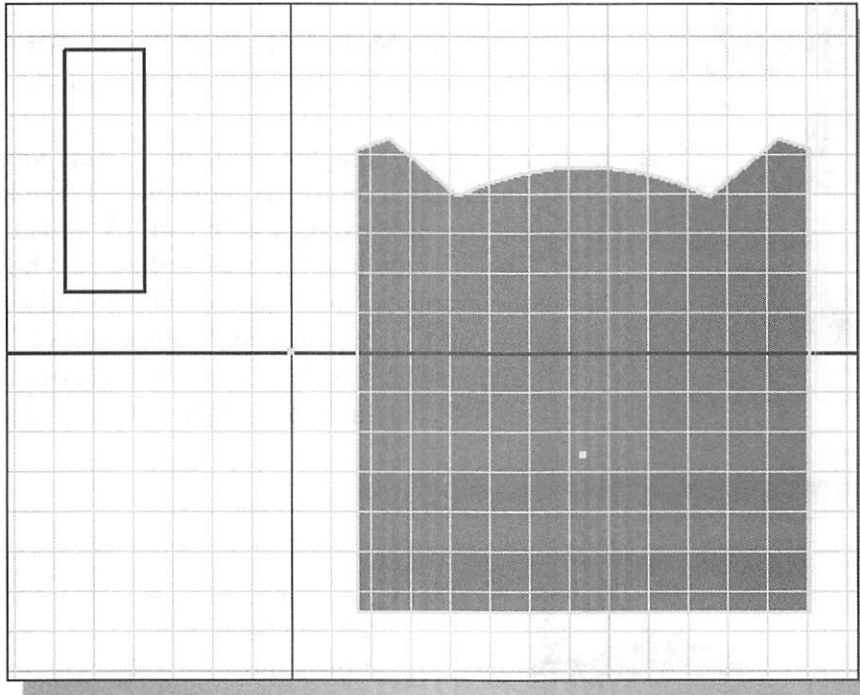

5. Select the **General Dimension** command in the *Constrain* toolbar. The **General Dimension** command allows us to quickly create and modify dimensions. Left-click once on the icon to activate the **General Dimension** command.

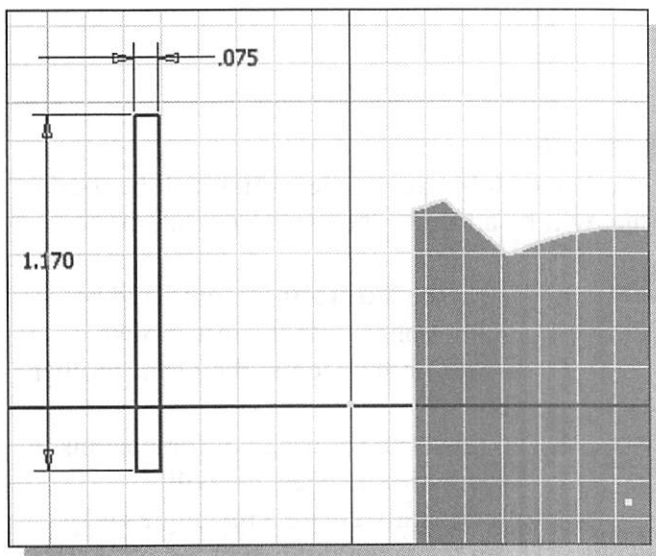

6. The message "*Select Geometry to Dimension*" is displayed in the *Status Bar* area at the bottom of the *Inventor* window. Create and modify the size dimensions to describe the size of the sketch as shown in the figure.

7. Create the two location dimensions to describe the position of the sketch relative to the top corner of the solid model as shown.

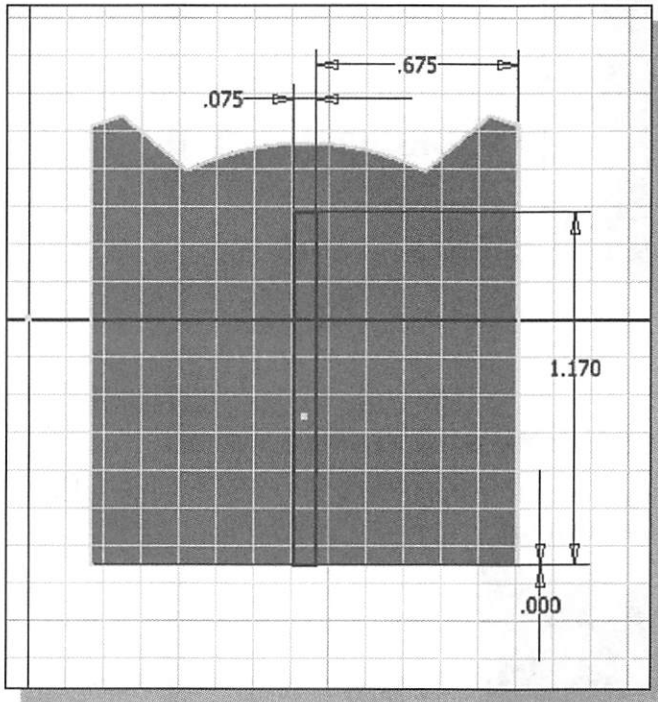
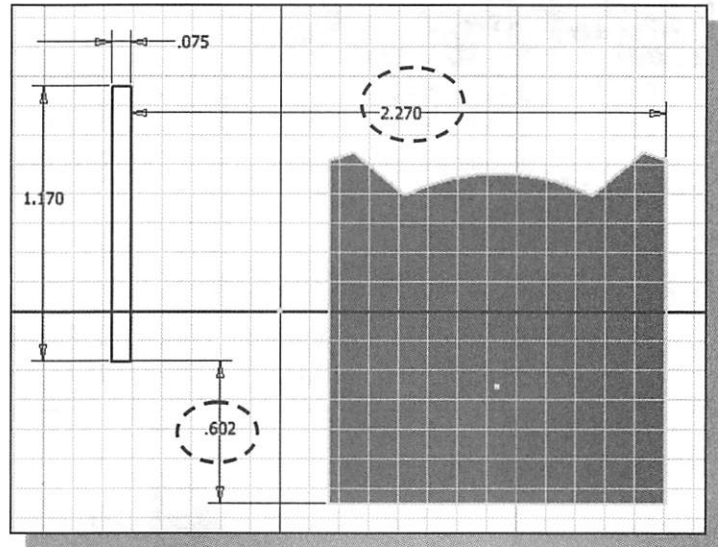

8. On your own, click on the associated location dimensions and modify them to **0.675** and **0.0** as shown in the figure.

➤ In parametric modeling, the dimensions can be used to quickly control the size and location of the defined geometry.

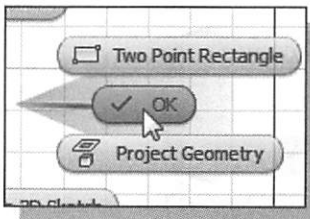

9. Inside the graphics window, click once with the **right-mouse-button** to display the option menu. Select **OK** in the popup menu to end the General Dimension command.

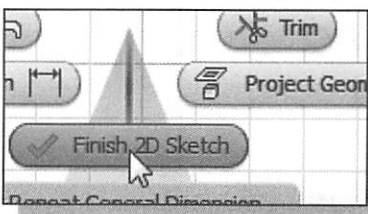

10. Inside the graphics window, click once with the **right-mouse-button** to display the option menu. Select **Finish 2D Sketch** in the popup menu to end the Sketch option.

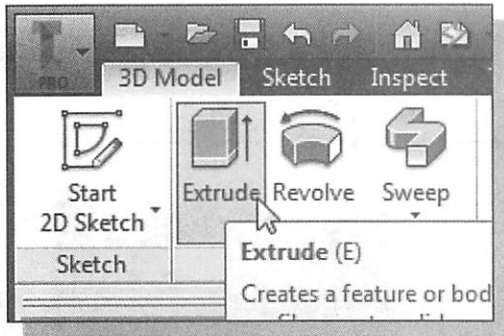

11. In the *Create* toolbar (the toolbar that is located to the right side of the *Sketch* toolbar in the *Ribbon*) select the **Extrude** command by clicking the left-mouse-button on the icon.

12. In the *Extrude* popup window, notice the **Profile** button is activated; *Autodesk Inventor* expects us to identify the profile to be extruded.

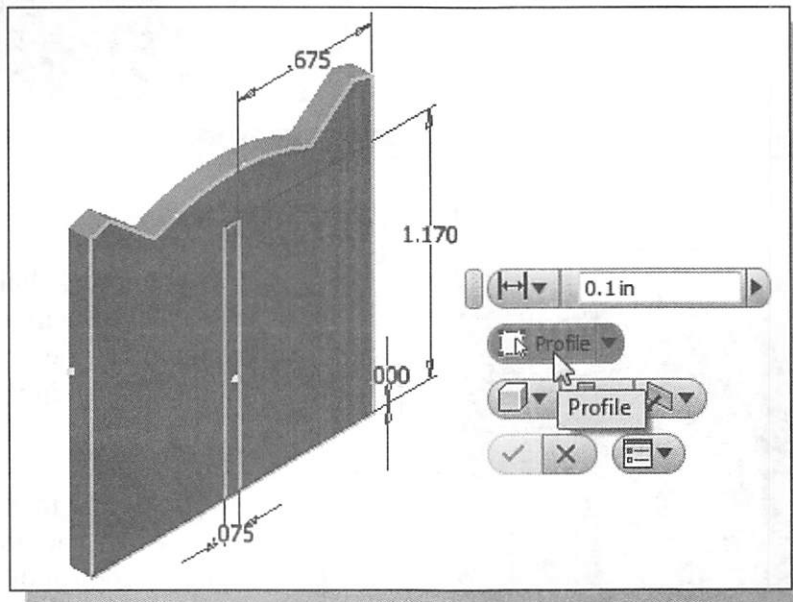

13. Move the cursor inside the rectangle we just created and left-click once to select the inside region as the profile to be extruded.

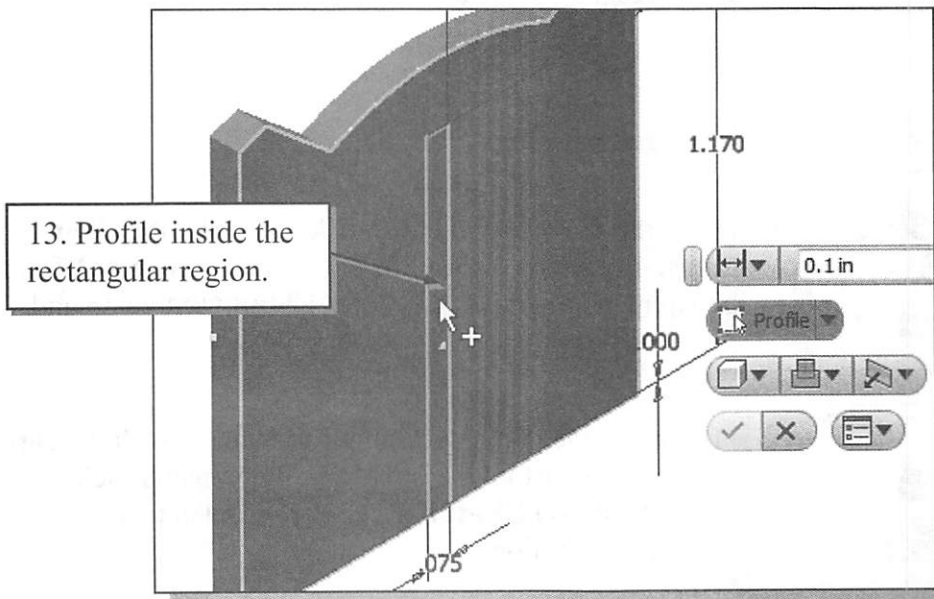

14. In the *Extrude* control panel enter **0.45** as the extrude distance as shown.

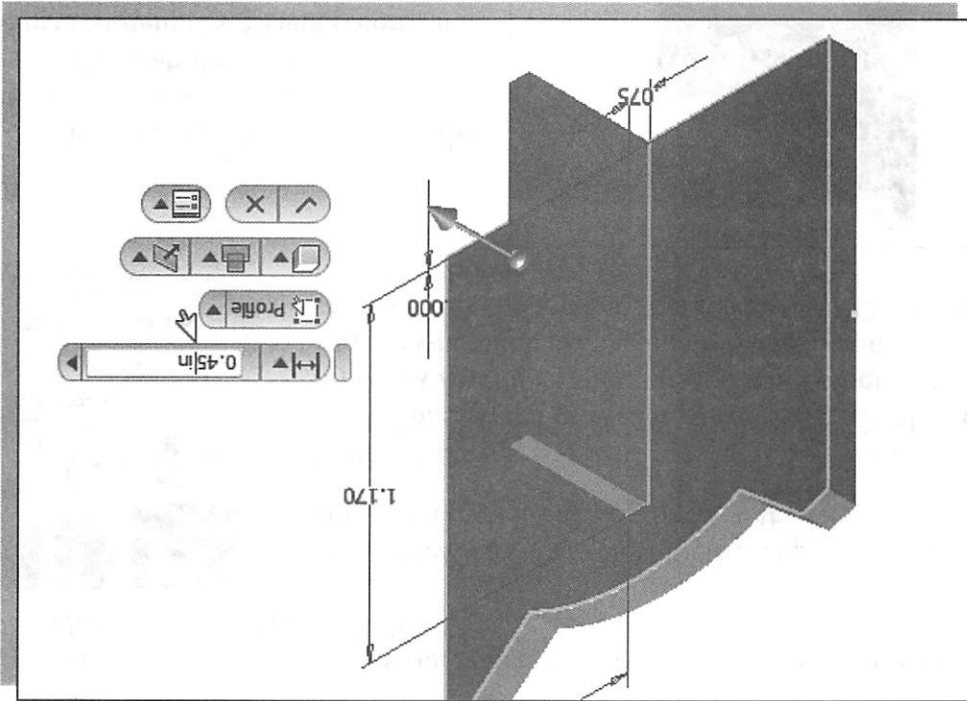

15. On your own, confirm the preview of the extruded feature appears as shown in the above figure.

16. Click on the **OK** button to proceed with creating the extruded feature.

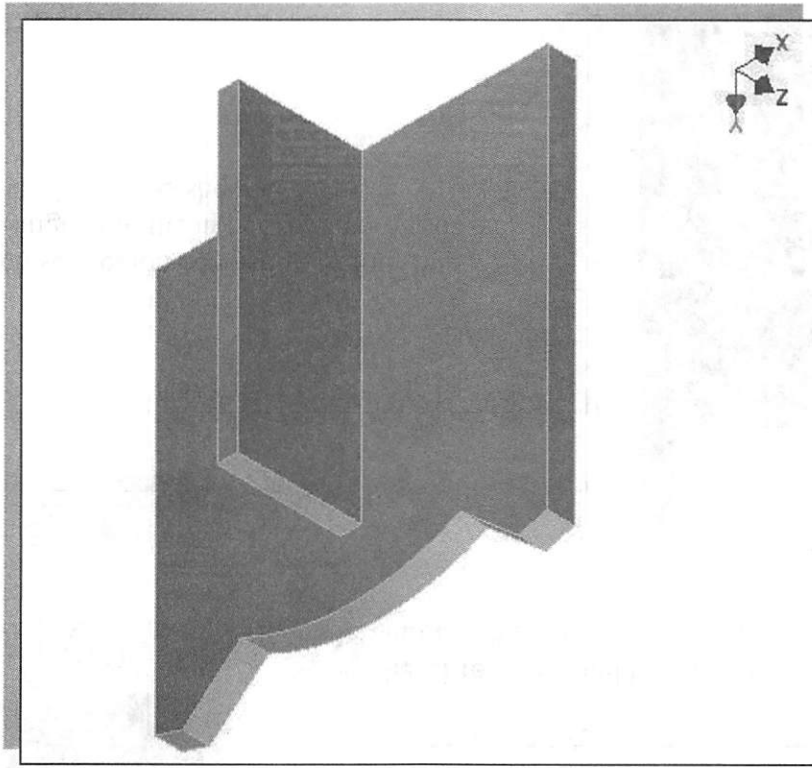

Step 4-2: Adding a Cut Feature

- Next, we will create and profile a circle, which will be used to create a cut feature that will be added to the existing solid object.

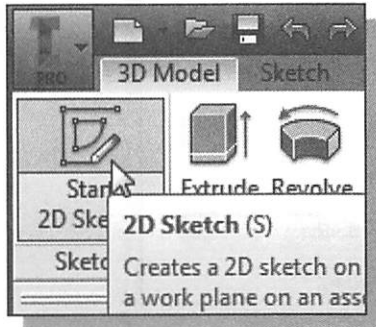

- In the *Sketch* toolbar select the **Start 2D Sketch** command by left-clicking once on the icon.
- In the *Status Bar* area, the message “*Select face, workplane, sketch or sketch geometry.*” is displayed. *Autodesk Inventor* expects us to identify a planar surface where the 2D sketch of the next feature is to be created. Pick the top horizontal face of the 3D solid model as shown.

- Note that the sketch plane is aligned to the selected face. *Autodesk Inventor* automatically establishes a User Coordinate System (UCS) and records its location with respect to the part on which it was created.

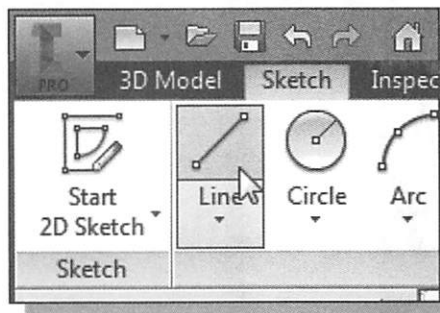
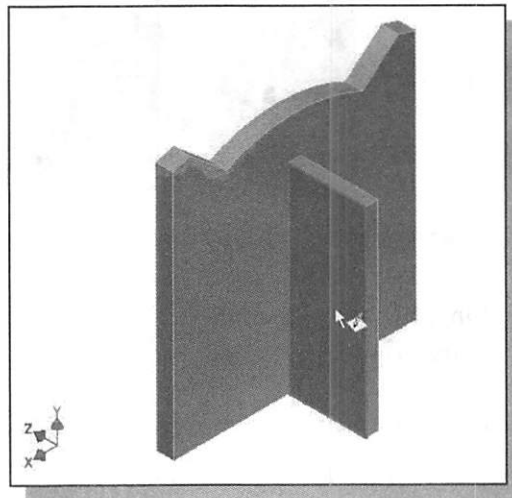

- Select the **Line** command by clicking once with the **left-mouse-button** on the icon in the *Draw* toolbar.

- Create a closed region consisting of four line segments aligned to the upper right corner of the second solid feature as shown.

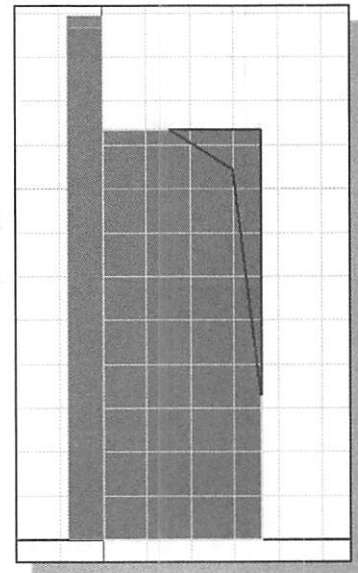

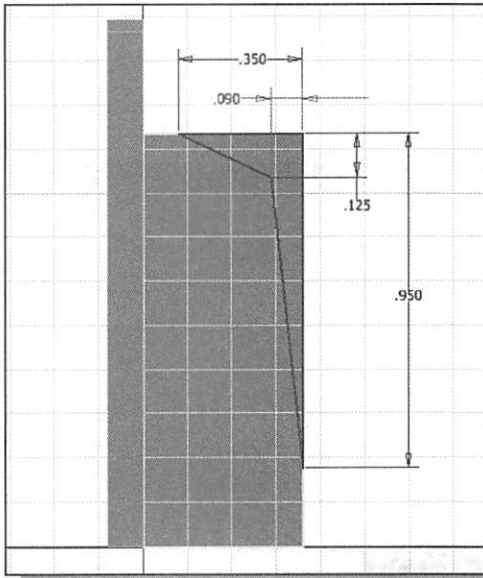

5. On your own, create and modify the dimensions of the sketch as shown in the figure.

6. Inside the graphics window, click once with the **right-mouse-button** to display the option menu. Select **OK** in the popup menu to end the General Dimension command.

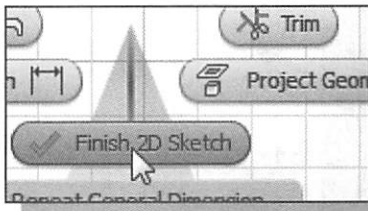

7. Inside the graphics window, click once with the **right-mouse-button** to display the option menu. Select **Finish 2D Sketch** in the popup menu to end the Sketch option.

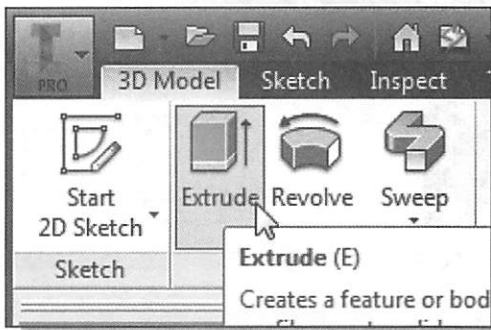

8. In the *Create* toolbar select the **Extrude** command by releasing the left-mouse-button on the icon.

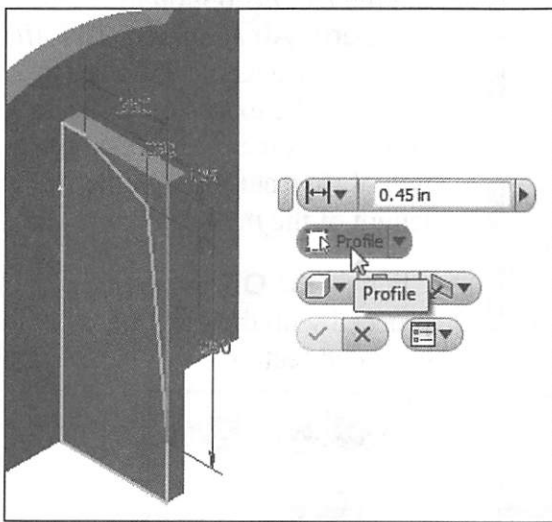

9. In the *Extrude* popup window, the **Profile** button is pressed down; *Autodesk Inventor* expects us to identify the profile to be extruded.

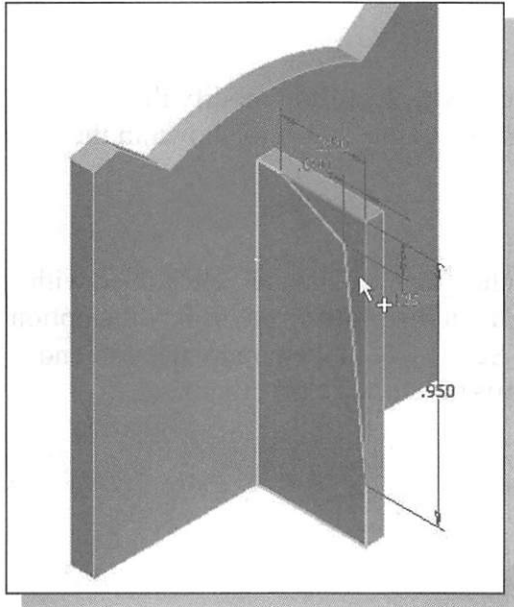

10. Click on the inside of the sketched region as shown.

11. Click on the **CUT** icon, as shown, to set the extrusion operation to *Cut*.

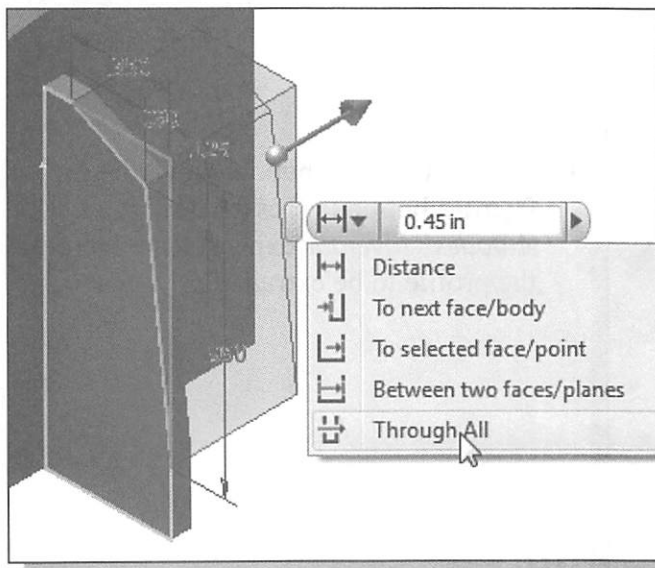
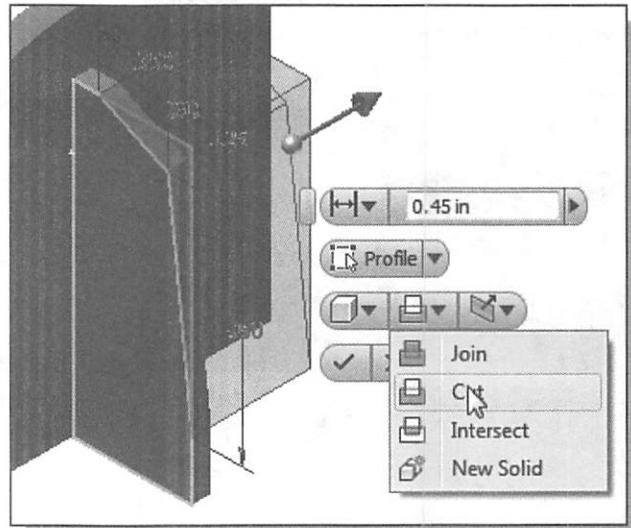

12. Set the *Extents* option to **Through All** as shown. The *All* option instructs the software to calculate the extrusion distance and assures the created feature will always cut through the full length of the model.

13. Click on the **OK** button to proceed with creating the extruded feature.

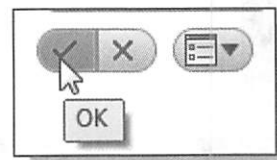

Step 5: Adding Additional Features

- Next, we will create and profile another sketch, a circle, which will be used to create another extrusion feature that will be added to the existing solid object.

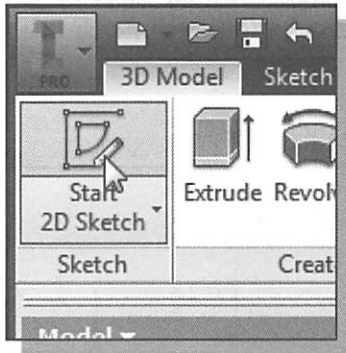

1. In the *Sketch* toolbar select the **Start 2D Sketch** command by left-clicking once on the icon.

2. Pick the bottom horizontal face of the 3D solid model as shown.

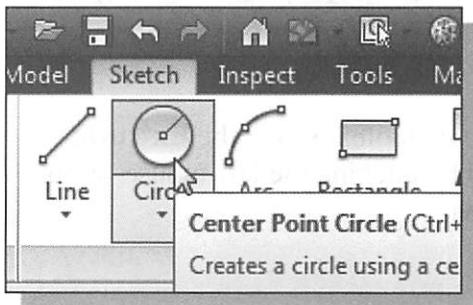
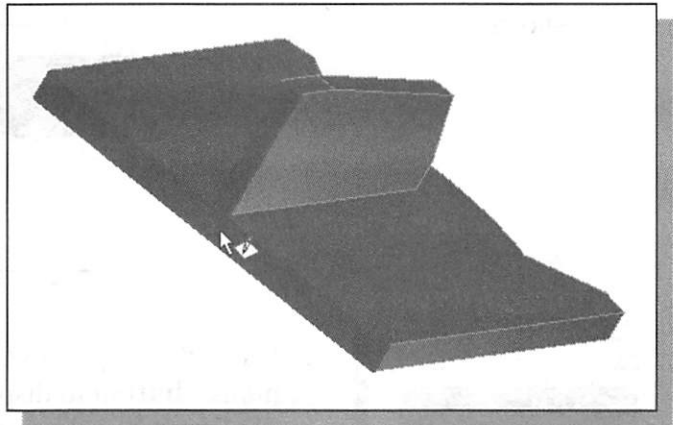

3. Select the **Circle** command by clicking once with the **left-mouse-button** on the icon in the *Draw* toolbar.

4. Create a circle near the right edge of the bottom surface as shown.

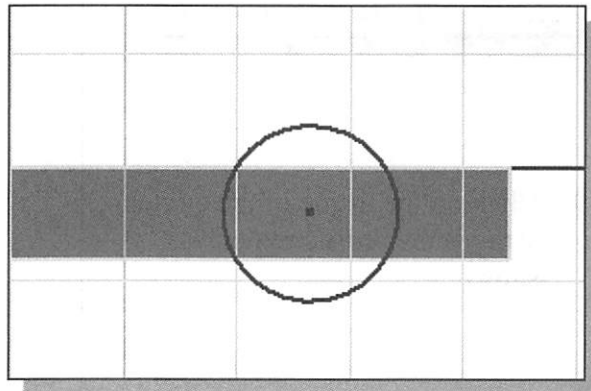

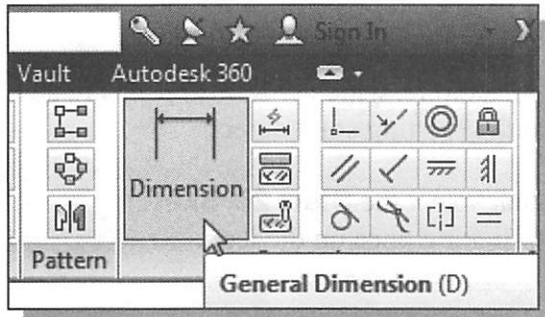

5. Select the **General Dimension** command in the *Constraint* toolbar. The **General Dimension** command allows us to quickly create and modify dimensions.

6. On your own, create and modify the three dimensions as shown.

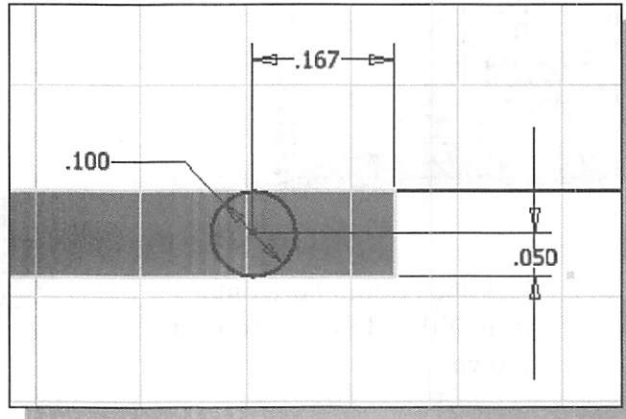

7. Inside the graphics window, click once with the **right-mouse-button** to display the option menu. Select **Finish 2D Sketch** in the popup menu to end the Sketch option.

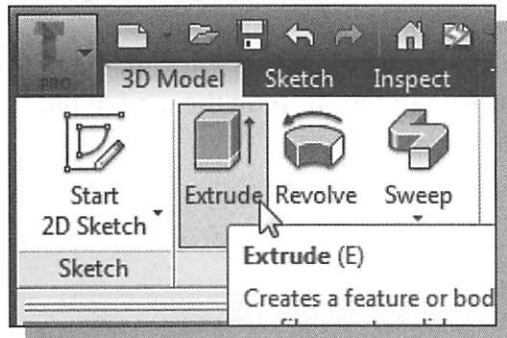

8. In the *Create* toolbar select the **Extrude** command by clicking the left-mouse-button on the icon.

9. Click on the inside of the circle to set it as the profile region as shown.

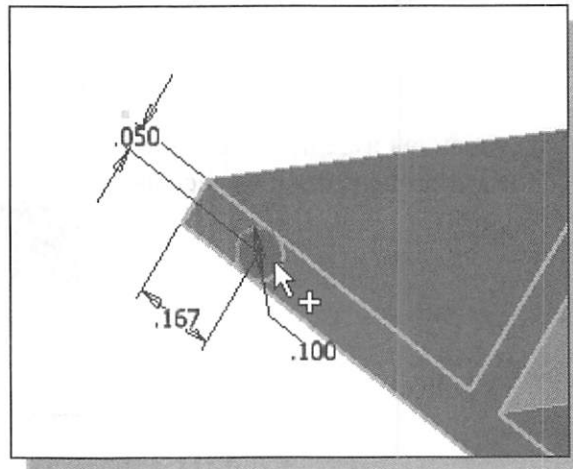

10. On your own, enter **0.32** as the extrude distance as shown.

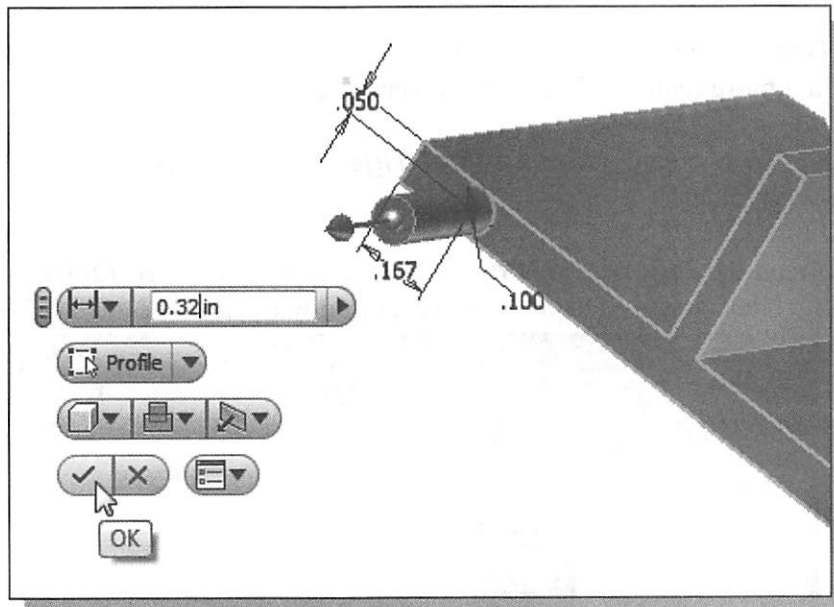

11. Click on the **OK** button to proceed with creating the extruded feature.
12. On your own, repeat the above steps and create another extruded feature on the other side.

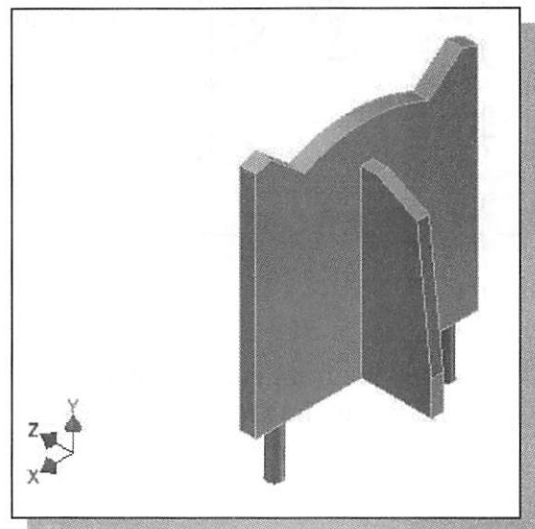
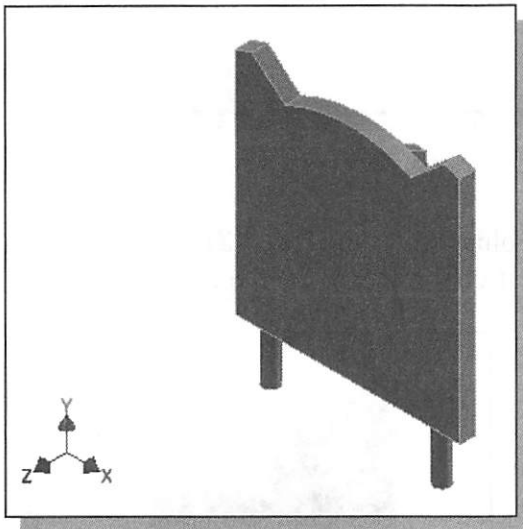

Using the Decal Command

- ❖ The **Decal** command can be used to apply a bitmap image on a flat surface to obtain a more realistic three-dimensional model.
1. On your own, create a **Mechanical-Tiger** project folder under the *Parametric Modeling* folder.
 2. Download the **TigerFace.bmp** file and save it to the *Mechanical-Tiger* project folder. (URL: www.SDCpublications.com/downloads/978-1-58503-966-1)

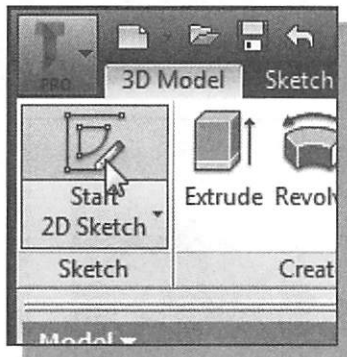
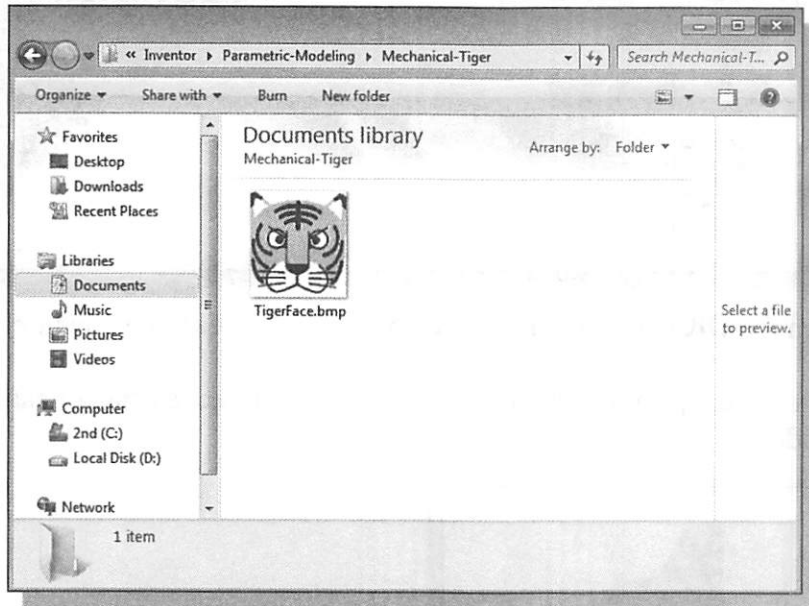

3. In the *Sketch* toolbar select the **Start 2D Sketch** command by left-clicking once on the icon.

4. Pick the front face of the 3D solid model as shown.

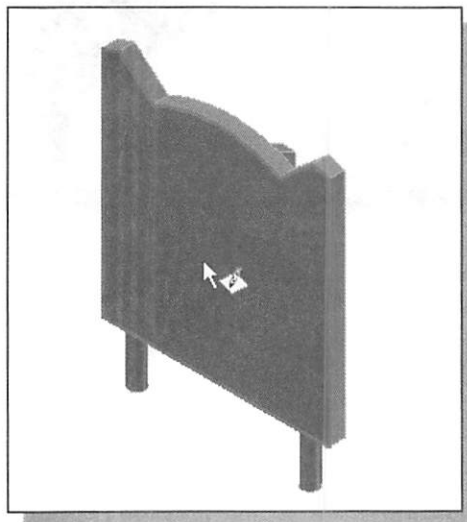

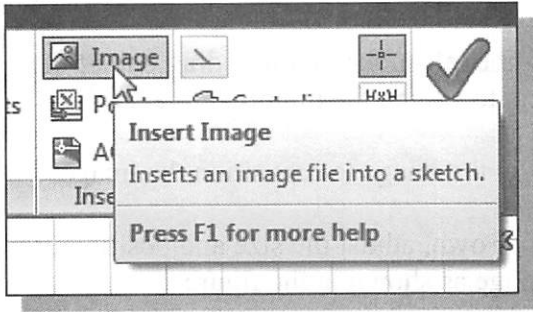

5. Select the Insert Image command in the *Insert* toolbar as shown.

6. Select the *TigerFace.bmp* in the *Mechanical-Tiger* project folder.

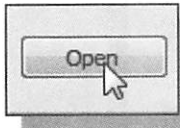

7. Click Open to import the image into the current sketch.

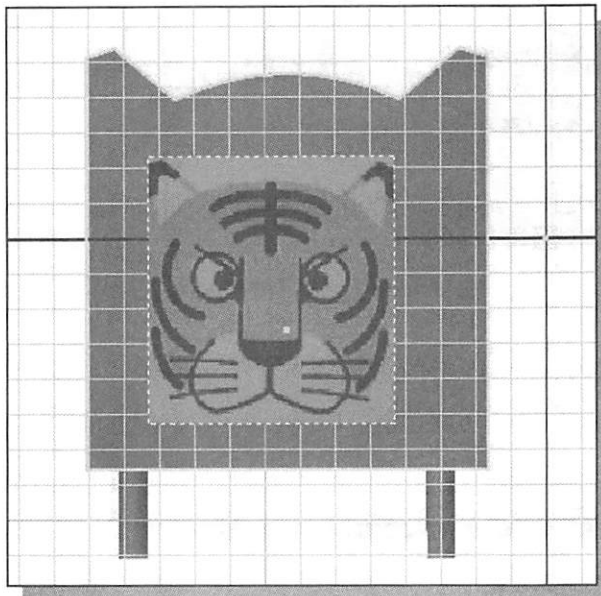

8. Place the image on the front face as shown.

9. Click once with the right-mouse-button to bring up the option menu. Select OK in the option menu to end the command.

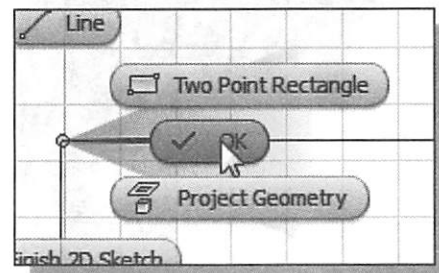

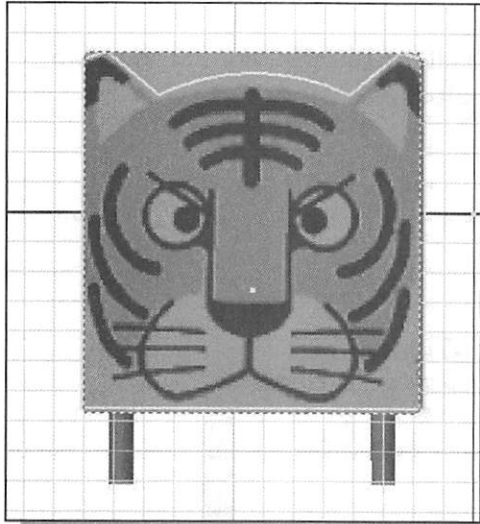

10. Using the left-mouse-button, drag one of the corners to stretch the imported image.
11. Drag on the image to reposition the image.
12. On your own, adjust the size and position of the image as shown in the figure.



13. Click **Finish Sketch** in the *Exit* toolbar to end the Sketch option.

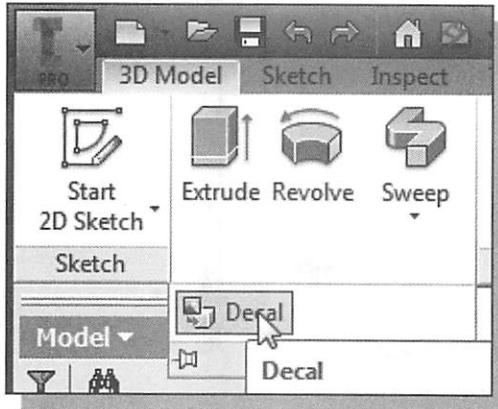

14. Select **Decal** in the *Create* toolbar to activate the command.

15. Select the *TigerFace* image as shown.

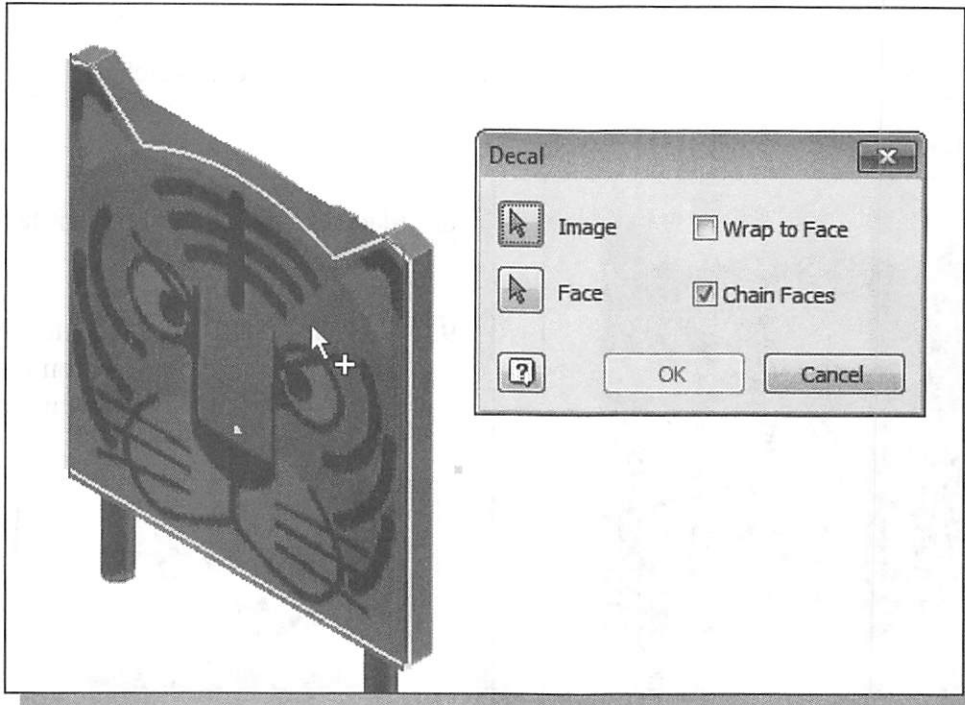

16. Select the front face of the solid model as shown.

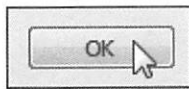
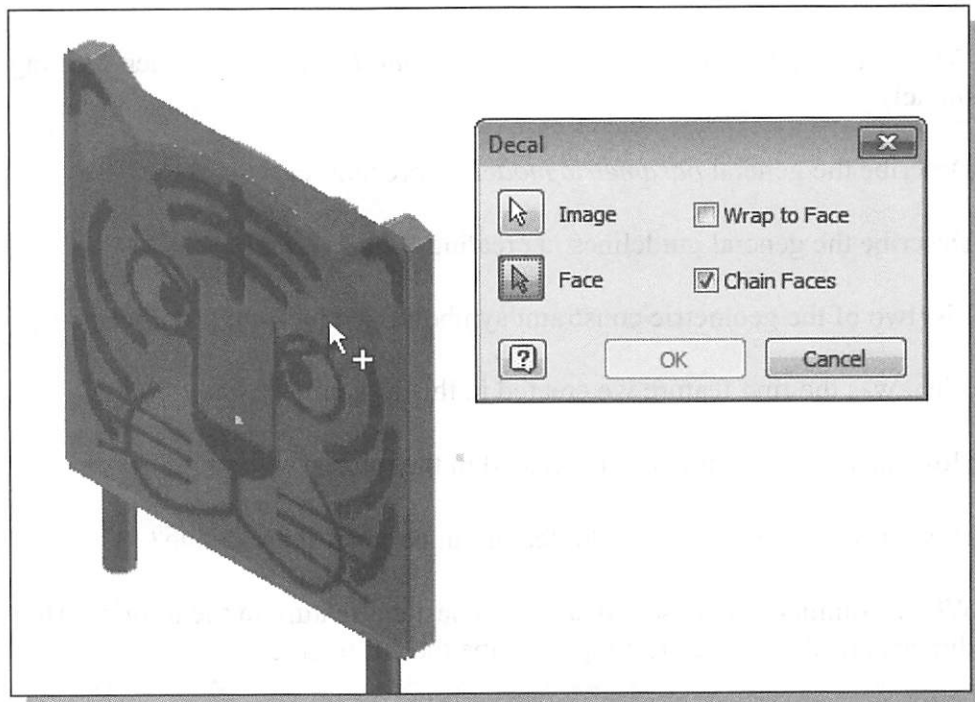

17. Click OK to accept the settings and complete the solid model.

Save the Model

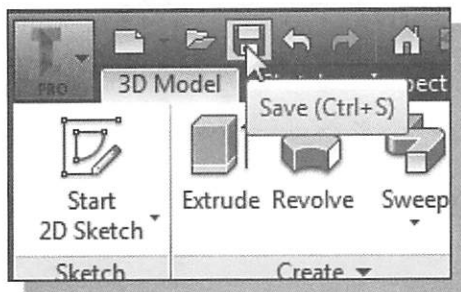

1. Select **Save** in the *Quick Access* toolbar, or you can also use the “**Ctrl-S**” combination (hold down the “**Ctrl**” key and hit the “**S**” key once) to save the part.

2. In the *File name* editor box, enter **TigerHead** as the file name.

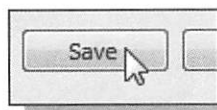
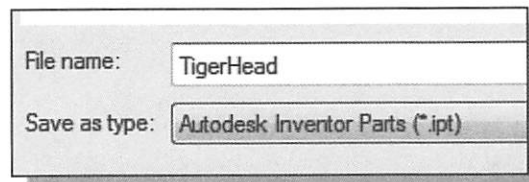

3. Click on the **Save** button to save the file.

- ❖ You should form a habit of saving your work periodically, just in case something might go wrong while you are working on it. In general, you should save your work at an interval of every 15 to 20 minutes. You should also save before making any major modifications to the model.

Review Questions:

1. What is the first thing we should set up in *Autodesk Inventor* when creating a new model?
2. Describe the general *parametric modeling* procedure.
3. Describe the general guidelines in creating *rough sketches*.
4. List two of the geometric constraint symbols used by *Autodesk Inventor*.
5. What was the first feature we created in this lesson?
6. How many solid features were created in the tutorial?
7. How do we control the size of a feature in parametric modeling?
8. Which command was used to create the last cut feature in the tutorial? How many dimensions do we need to fully describe the cut feature?
9. List and describe three differences between parametric modeling and traditional 2D Computer Aided Drafting techniques.

Exercises:

1. Inclined Support (Thickness: .5)

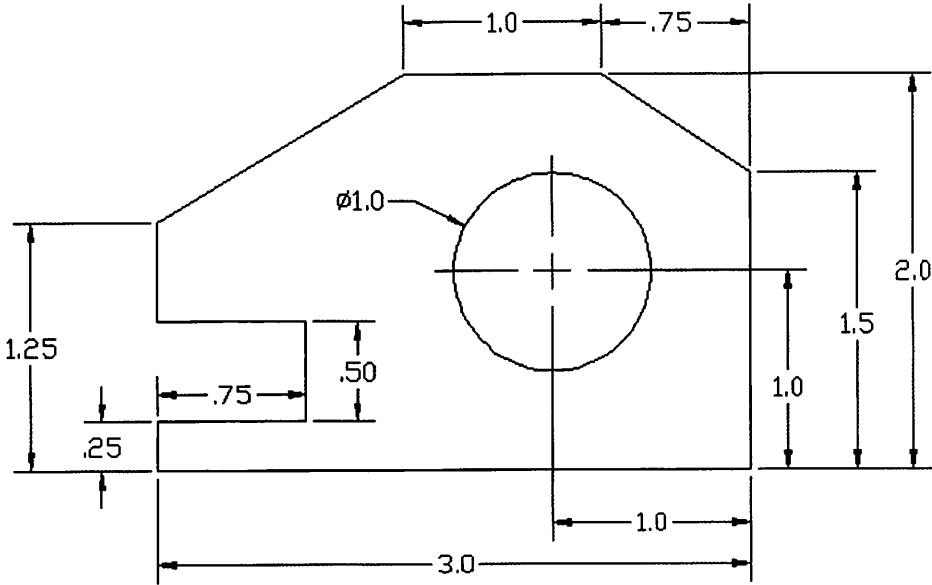

2. Spacer Plate (Thickness: .125)

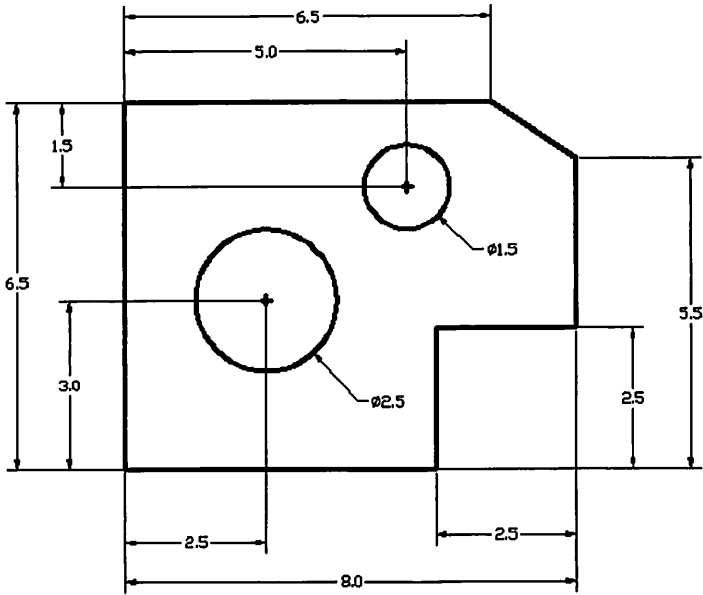

Notes: